

CORSICA 44
ART.NR. 441600
1/8

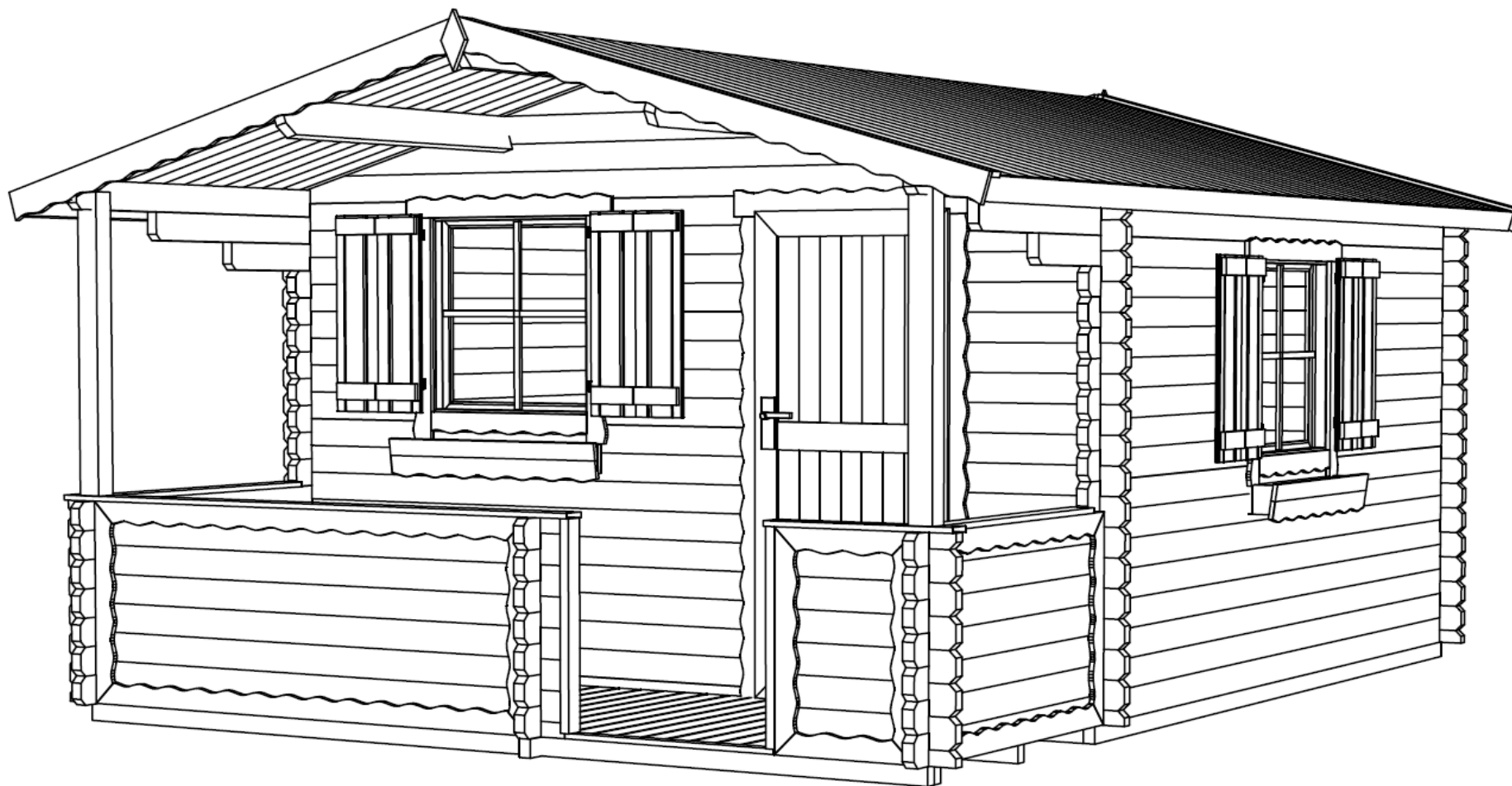

24.10.2014

GROUNDPLAN - GRUNDPLAN - PLAN DE MASSE

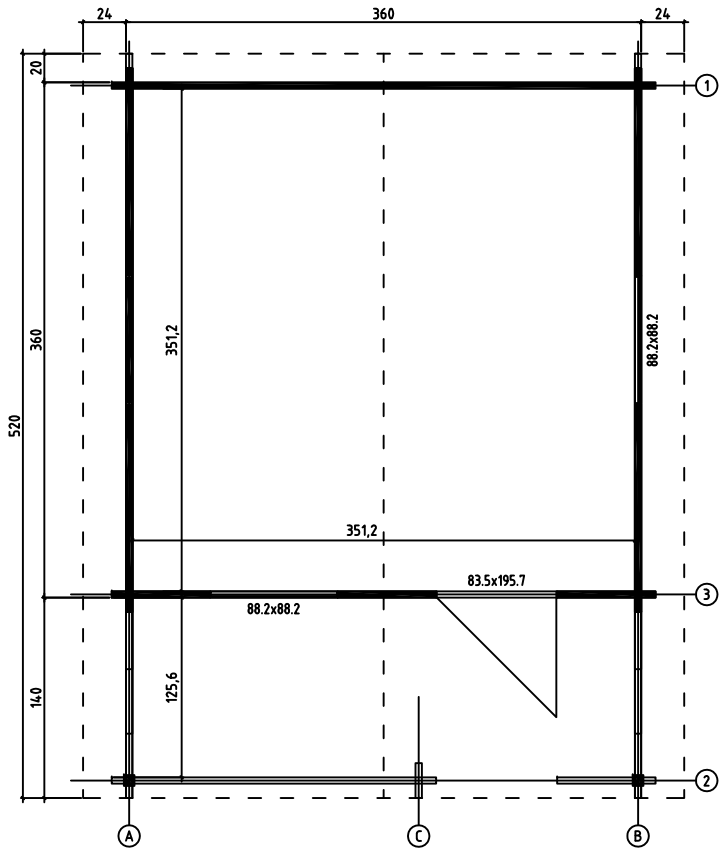

FOUNDATION - FUNDAMENT - FONDATION

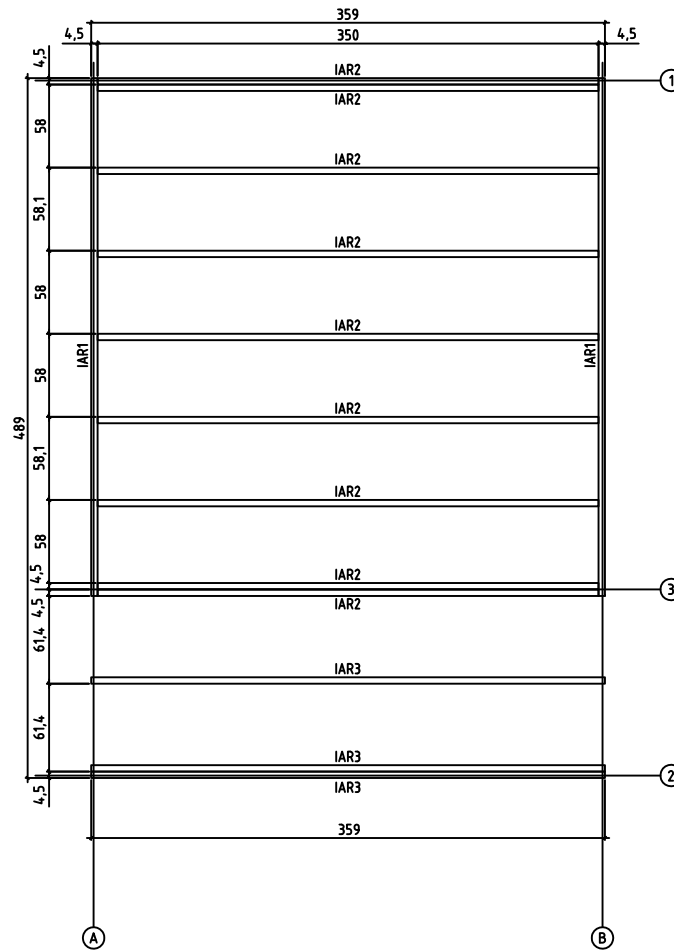



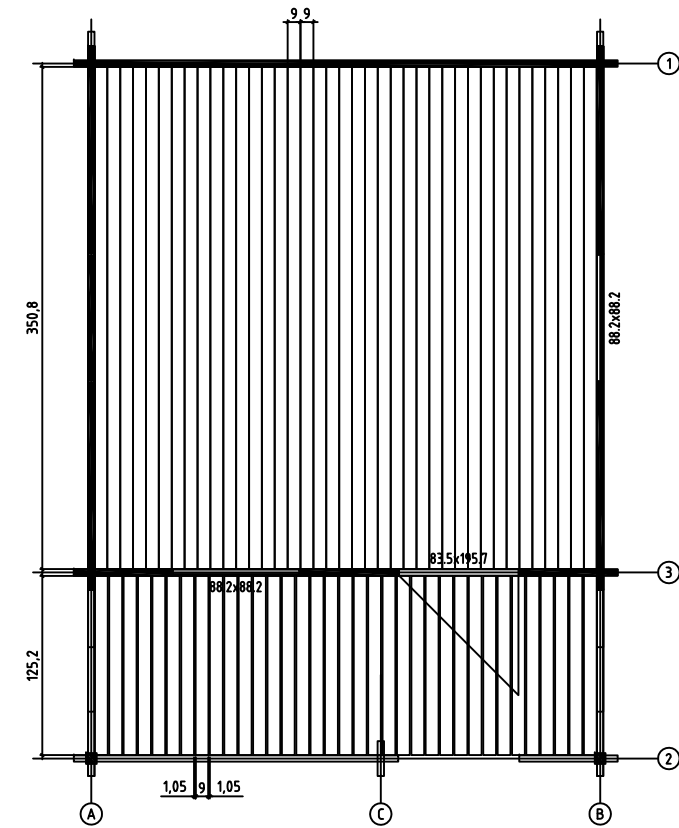

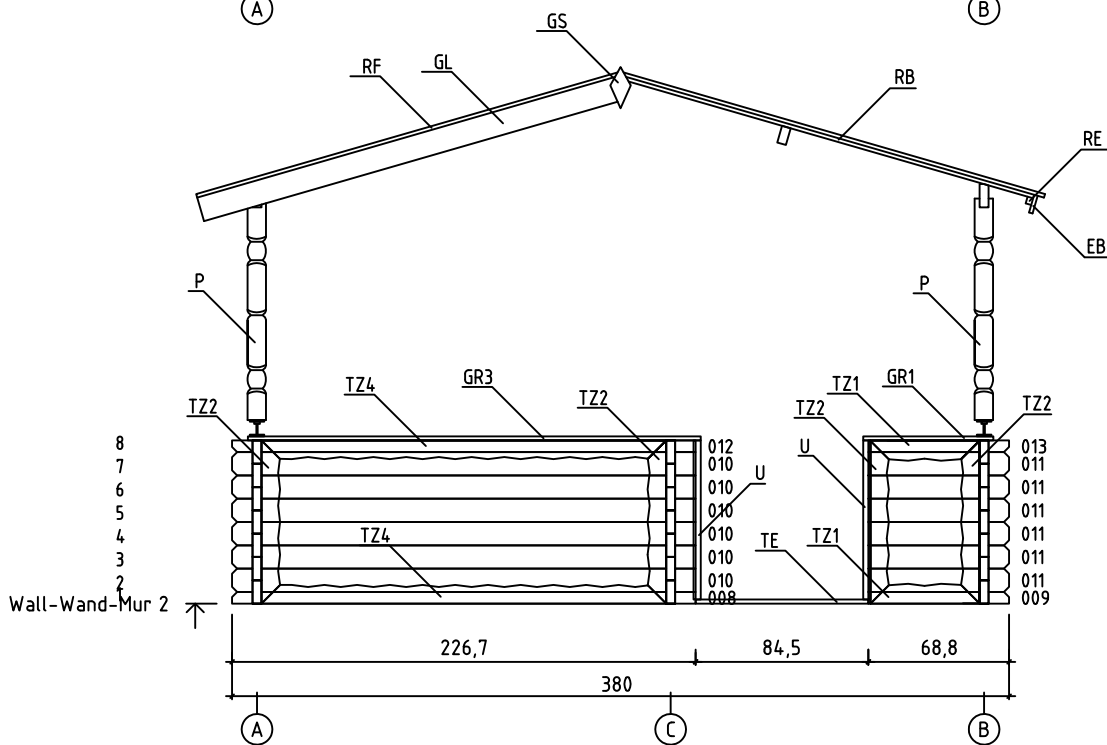
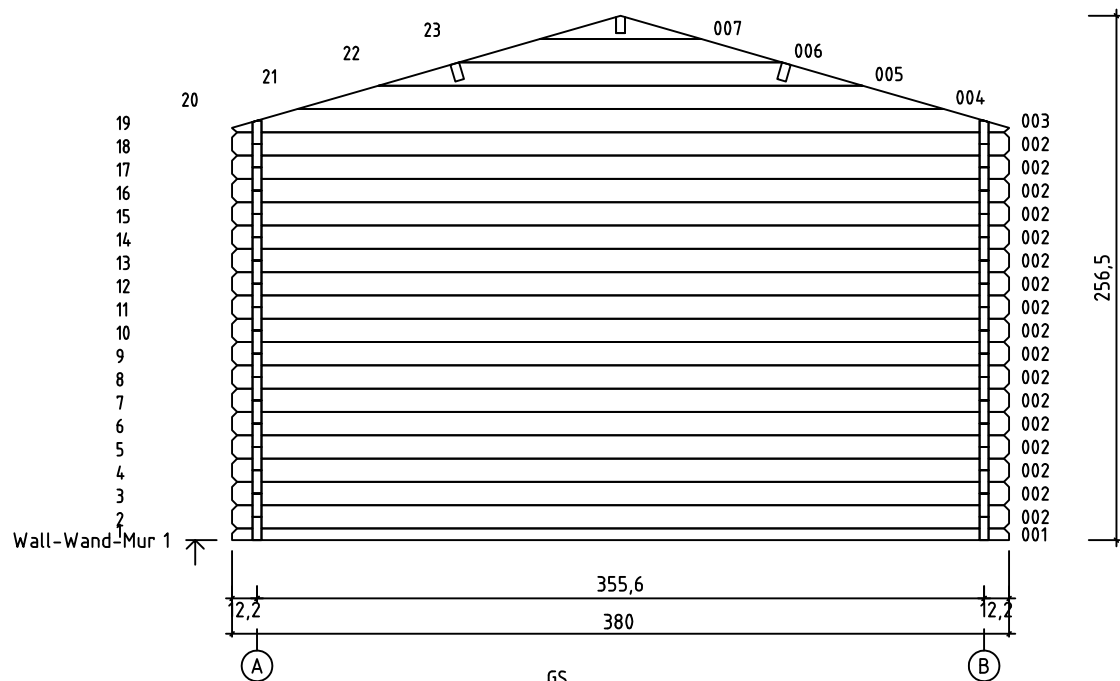
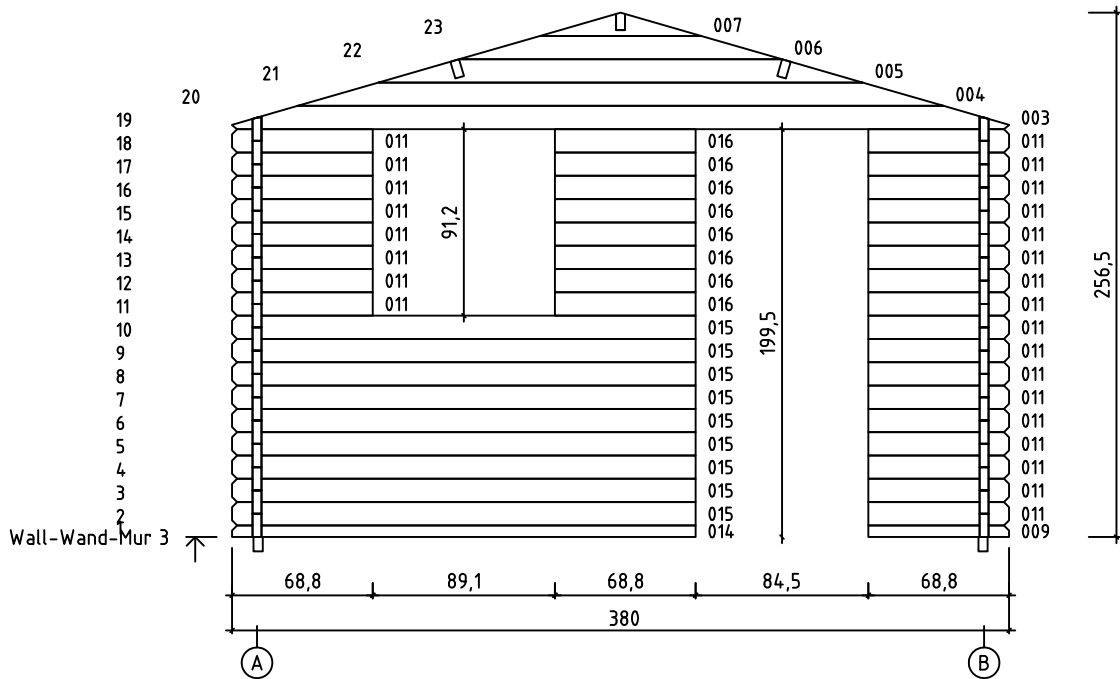

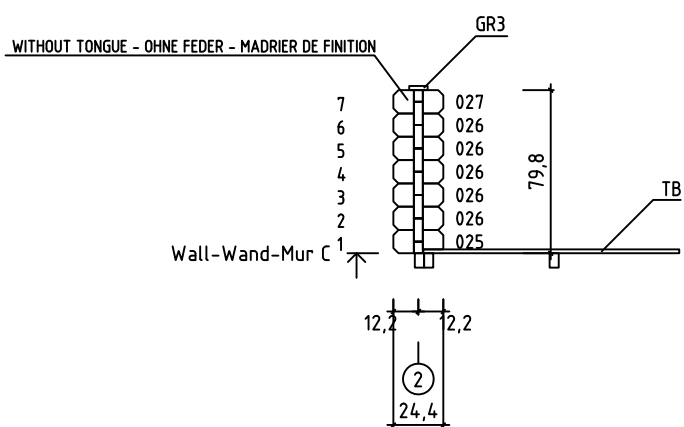
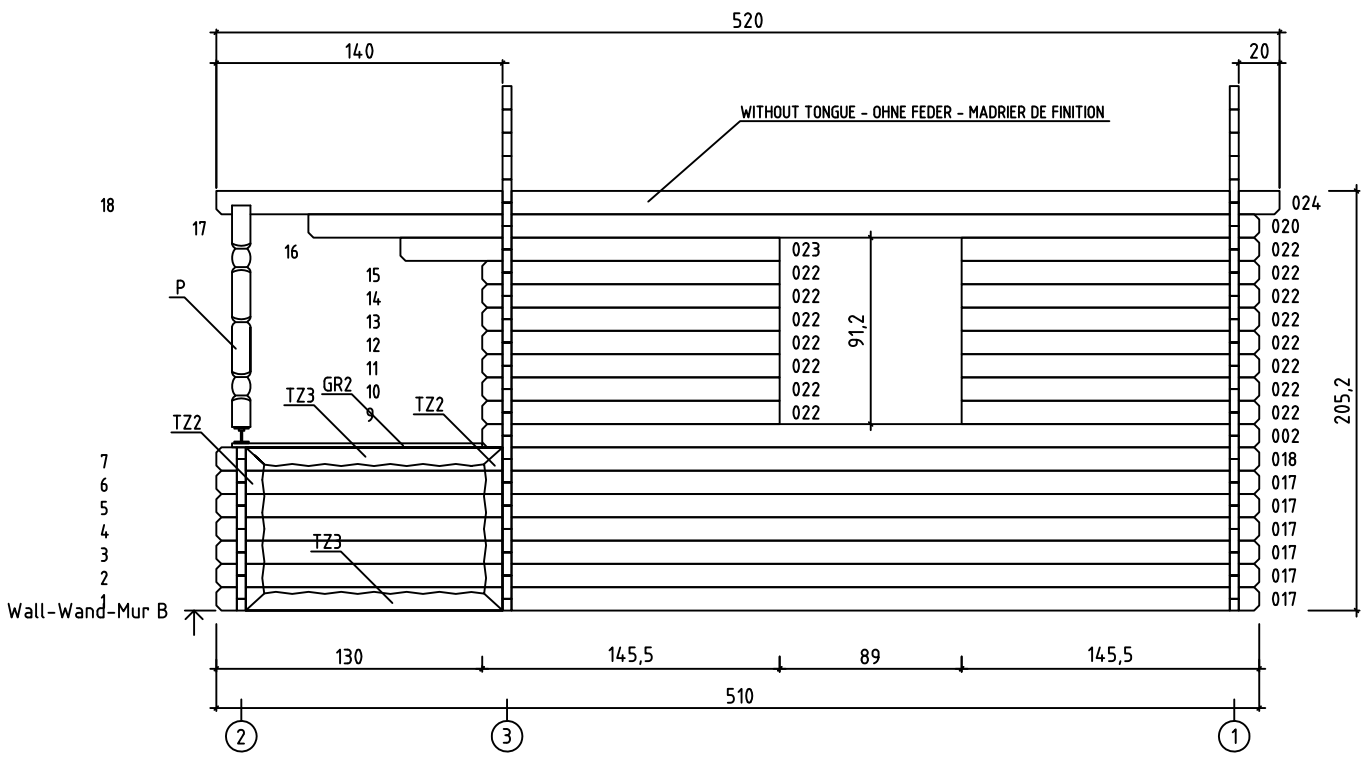
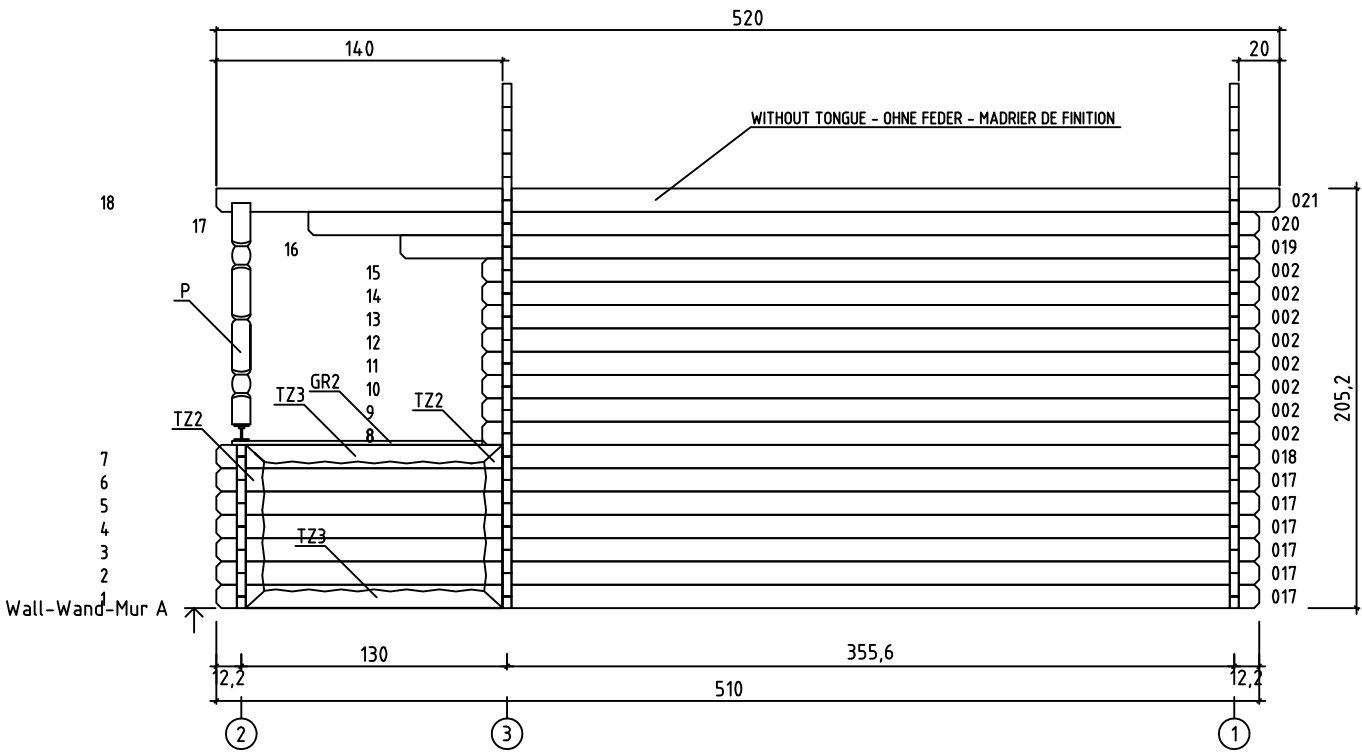

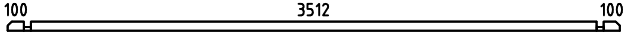
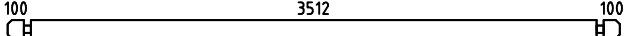
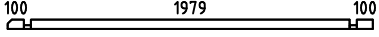
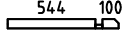
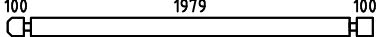
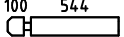
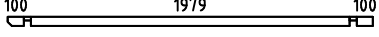
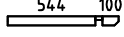
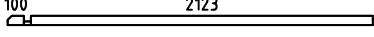
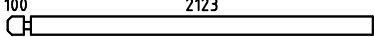
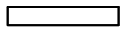

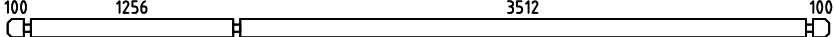
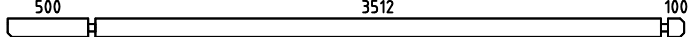
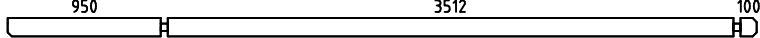
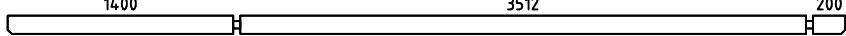
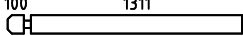
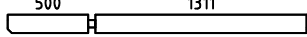
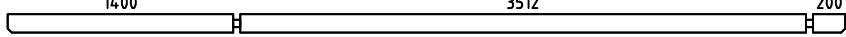



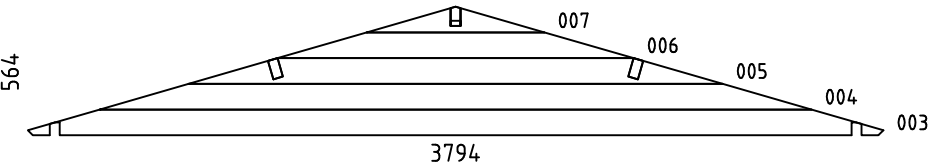

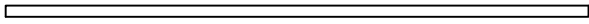
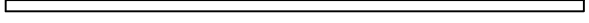
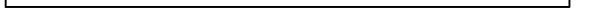
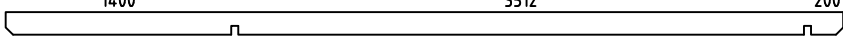
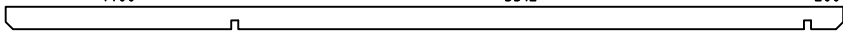





FLOOR BOARDS - FUSSBODENBRETTER - PLAN POSE PLANCHER





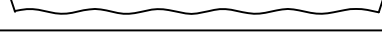
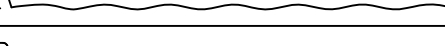
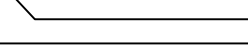
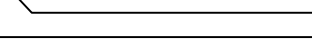
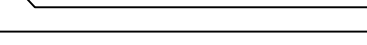
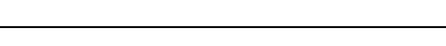

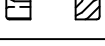





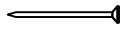
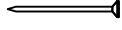
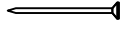
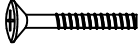
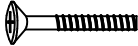



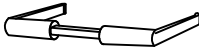
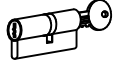

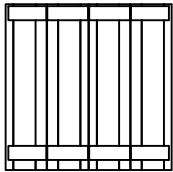
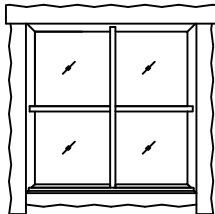
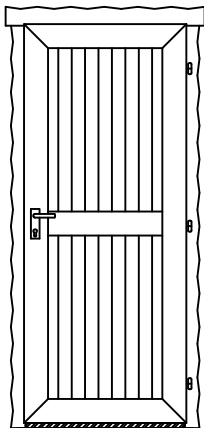

Pos	24.10.2014	ART.NR. 441600	5/8	Q.	P (mm)	L (mm)
001				1	44x57	3800
002				26	44x114	3800
008				1	44x57	2267
009				2	44x57	688
010				6	44x114	2267
011				31	44x114	688
012				1	44x57	2267
013				1	44x57	688
014				1	44x57	2267
015				9	44x114	2267
016				8	44x114	688
017				12	44x114	5100
018				2	44x114	5100
019				1	44x114	4200
020				2	44x114	4650
021				1	44x120	5200
022				15	44x114	1455
023				1	44x114	1855
024				1	44x120	5200
025				1	44x114	244
026				5	44x114	244
027				1	44x114	244
W1-1 W3-1				1 1		





Pos	24.10.2014	ART.NR. 441600	6/8	Q.	P (mm)	L (mm)
IAR1	FOUNDATION - FUNDAMENT - FONDATION 			2	45x70	3618
IAR3	FOUNDATION - FUNDAMENT - FONDATION 			3	45x70	3590
IAR2	FOUNDATION - FUNDAMENT - FONDATION 			9	45x70	3500
PR11	ROOF BEAM - DACHBALKEN - PANNE DE TOIT 1400 3512 200 			1	44x140	5200
PR21	ROOF BEAM - DACHBALKEN - PANNE DE TOIT 1400 3512 200 			2	44x140	5200
	FLOOR BOARDS - FUSSBODENBRETTER - LAME DE PLANCHER 			39	90x18	3508
RB	ROOF BOARDS - DACHBRETTER - VOLIGES 			116	90x18	2100
TB	TERRACE BOARDS - TERRASSENBRETTER - PLANCHER DE TERRASSE 			35	90x19	1252
	FLOOR FILLET-FUSSBODENLEISTE - CORNIERE DE FINITION DU PLANCHER 				18x18	14.03
TE	TERRACE EDGE BOARD - TERRASSENBRETT, EINGANG - LAME DE SEUIL D'ENTREE DE TERRASSE 			1	19x44	843
RF	ROOFING FELT FILLET - DACHPAPPENLEISTE - BAGUETTE DE FIXATION DU FEUTRE BITUMEUX 			4	18x58	2150
GL	GABLE MOULDING - GIEBELLEISTE - PLANCHE DE RIVE 			4	18x120	2150
EB	EAVES BOARD - TRAUFBRETT - BANDEAU DE TOIT 			4	18x90	2600
RE	ROOF EDGE REINFORCEMENT - DACHRANDVERSTÄRKUNG - CORNIERE DE RENFORT DE BORD DE TOIT 			4	28x34	2600
TZ1	DECORATIVE BOARDS OF THE TERRACE-TERRASSENZIERBRETTER - PLINTHE DÉCORATIVE DE FINITION DE LA TERRASSE 			2	18x90	532
TZ2	DECORATIVE BOARDS OF THE TERRACE-TERRASSENZIERBRETTER - PLINTHE DÉCORATIVE DE FINITION DE LA TERRASSE 			8	18x90	796
TZ3	DECORATIVE BOARDS OF THE TERRACE-TERRASSENZIERBRETTER - PLINTHE DÉCORATIVE DE FINITION DE LA TERRASSE 			4	18x90	1254
TZ4	DECORATIVE BOARDS OF THE TERRACE-TERRASSENZIERBRETTER - PLINTHE DÉCORATIVE DE FINITION DE LA TERRASSE 			2	18x90	1977
GR1	GUARD-RAIL FOR TERRACE - TERRASSENGELÄNDER MAIN COURANTE DE TERRASSE 			1	18x90	636
GR2	GUARD-RAIL FOR TERRACE - TERRASSENGELÄNDER MAIN COURANTE DE TERRASSE 			2	18x90	1223
GR3	GUARD-RAIL FOR TERRACE - TERRASSENGELÄNDER MAIN COURANTE DE TERRASSE 			1	18x90	2215
	STORM PROTECTION - STURMLEISTE - LATTE ANTI-TEMPETE 			4	22x45	2000
P	POST - PFOSTEN - POTEAU 			2	90x90	1080
U	U-PROFILE - TERRASSENEINFASSUNG - PROFILE U 			2	35x70	778
	WINDOW HANDLE FITTINGS-FENSTERGRIFF - POIGNÉE D'OUVERTURE DE FENETRE 			2		

Pos	24.10.2014	ART.NR. 441600	7/8	Q.	P (mm)	L (mm)
	HINGE FOR SHUTTERS - SCHARNIER FÜR FENSTERLÄDEN - CHARNIERE POUR VOLETS			8		
	SCREW FOR GEORGIAN BARS - SCHRAUBE FÜR SPROSSEN - VIS DE BARRES GEORGIENNE			8	2.5x20	
	SCREW FOR SHUTTERS FILLET - SCHRAUBE ZUR BEFESTIGUNG FENSTERLÄDENLEISTE - VIS D'ASSEMBLAGE DU CADRE DE DE VOLETS DE FENETRE			6	3x30	
	SCREW FOR GABLE SEGMENT - SCHRAUBEN FÜR DECKBLATT - VIS POUR FIXATION LOSANGE DE FINITION			4	3.5x35	
	SCREW FOR U-PROFILE - SCHRAUBE ZUR BEFESTIGUNG U-PROFILS- VIS A TETE FRAISÉE POUR PROFIL U			6	3.5x50	
	SCREW FOR GABLE MOULDING - SCHRAUBEN FÜR GIEBELLEISTE - VIS DE FIXATION POUR PLANCHE DE RIVE			24	3.5x50	
	SCREW FOR POST - SCHRAUBEN FÜR PFOSTEN - VIS DE FIXATION DES POTEAUX			4	4.5x80	
	SCREW FOR EAVES BOARDS - SCHRAUBEN FÜR TRAUFBRETT - VIS DE FIXATION POUR BANDEAU DE TOIT			24	4x40	
	SCREW FOR ROOF EDGE REINFORCEMENT - SCHRAUBEN FÜR DACHRANDVERSTÄRKUNG - VIS POUR RENFORT DE BORD DE TOIT			24	4x40	
	SCREW FOR SHUTTER HINGE - SCHRAUBE FÜR FENSTERLÄDEN SCHARNIER - VIS POUR SHUTTER CHARNIERE			16	4x40	
	SCREW FOR DECORATIVE BOARDS OF THE TERRACE - SCHRAUBEN FÜR TERRASSENZIERBRETT - VIS DE FIXATION DES PLINTHES DECORATIVES GARDE-CORPS DE LA TERRASSE			86	4x40	
	SCREWS FOR TERRACE BOARD - SCHRAUBEN FÜR TERRASSENBRETT - VIS DE FIXATION DE LAME DE SEUIL D'ENTREE DE TERRASSE			3	4x40	
	SCREW FOR TERRACE REAR BOARDS - SCHRAUBEN FÜR TERRASSENRAND - VIS DE FIXATION POUR MAIN COURANTE DE TERRASSE			18	4x40	
	SCREW FOR ROOF BEAMS - SCHRAUBEN FÜR DACHBALKEN - VIS POUR PANNE DE TOIT			10	5x120	
	SCREW FOR 1. WALL BEAM - SCHRAUBE FÜR 1. BOHLENREIHE - VIS DE FIXATION DES FONDATIONS			11	5x90	
	SCREW FOR FUNDAMENT - SCHRAUBEN ZUR BEFESTIGUNG FUNDAMENT - VIS POUR FONDATION			32	5x90	
	SCREW FOR 1. WALL BEAM - SCHRAUBE FÜR 1. BOHLENREIHE - VIS DE FIXATION DES FONDATIONS			1	6x150	
	SCREW FOR POST HEIGHT ADJUSTMENT - SCHRAUBEN FÜR REGULIERUNGSSCHRAUBE FÜR PFOSTEN - VIS DE FIXATION DE SUPPORT REGLABLE DE POTEAU			16	6x50	
	SCREW FOR DOORSTEP - SCHRAUBEN FÜR SWELLE - VIS DE FIXATION DU SEUIL DE PORTE			2	4.5x65	
	ZN NAIL FOR TERRACE - ZN NÄGEL FÜR TERRASSENBRETT - POINTE POUR PLANCHER DE TERRASSE			210	2.1x50	
	ZN NAIL FOR FLOOR FILLET - ZN NÄGEL FÜR FUSSBODENLEISTE -			28	1.4x40	
	SHUTTER HOOK - FESTSTELLER FENSTERLÄDEN - ARRETS DE VENTS POUR VOLETS			6		
	SHUTTER HOOK - FESTSTELLER FENSTERLÄDEN - ARRETS DE VENTS POUR VOLETS			4		
	NUT FOR STORM PROTECTION - SCHRAUBENMUTTER FÜR STURMLEISTE - ÉCROU POUR LAME ANTI-TEMPETE			8		
	HAMMER BLOCK - SCHLAGHOLZ - CALLE DE FRAPPE			1		

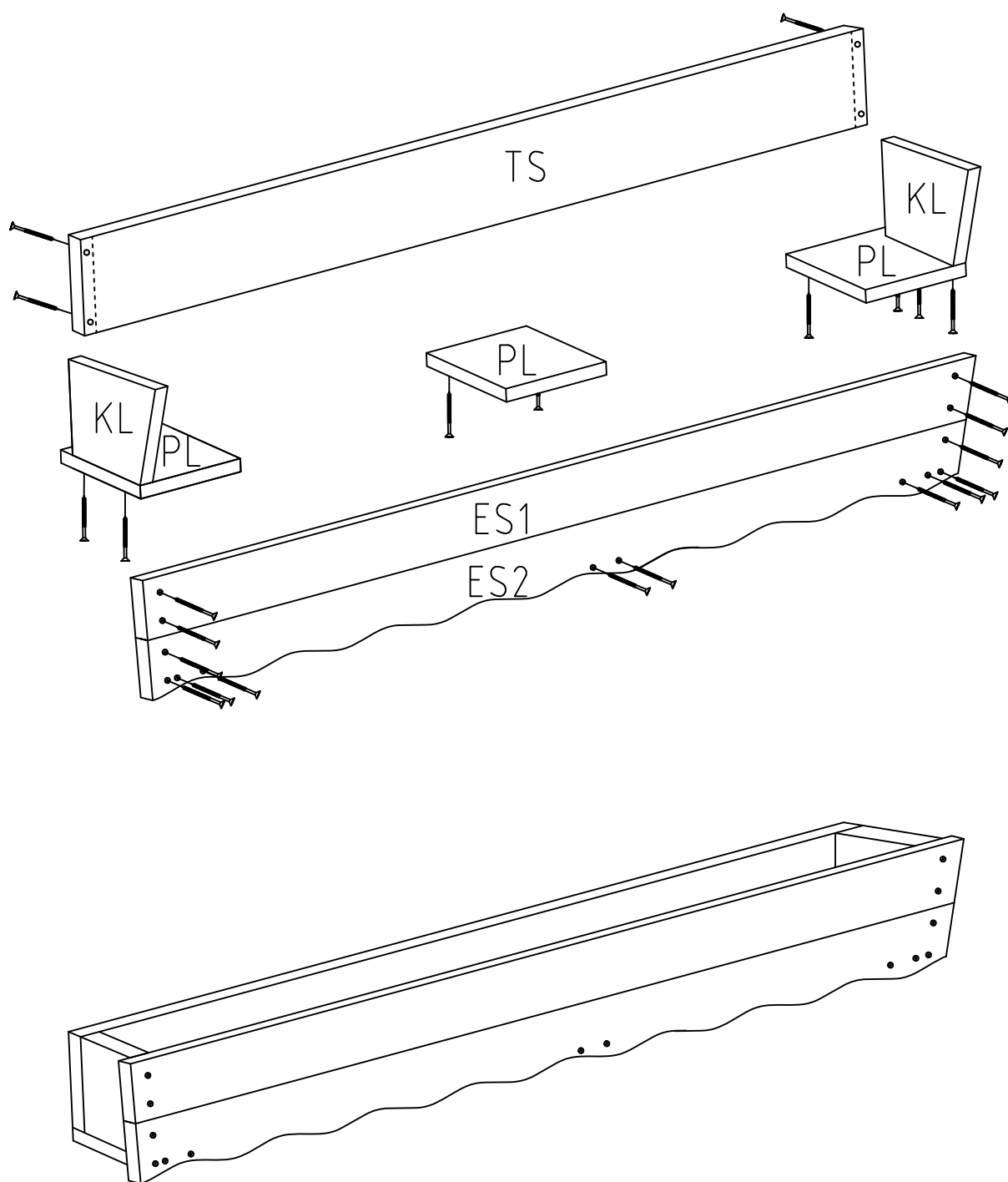
Pos	24.10.2014	ART.NR. 441600	8/8	Q.	P (mm)	L (mm)
	ZN NAIL FOR ROOFING FELT FILLET - ZN NÄGEL FÜR DACHPAPPENLEISTE - POINTE POUR BAGUETTE FIXATION FEUTRE BITUMEUX			20	2x50	
	ZN NAIL FOR ROOF - ZN NÄGEL FÜR DACHBRETTER - POINTE POUR TOIT			362	2x50	
	ZN NAIL FOR FLOOR - ZN NÄGEL FÜR FUSSBODENBRETTER - CLOUS POUR PLANCHER			280	2x50	
	BOLT FOR WINDOW HANDLE FITTINGS - BOLZEN FÜR FENSTERGRIFF BESCHLAG - BOULON POUR POIGNÉE D'OUVERTURE DE FENETRE			4		
	BOLT FOR STORM PROTECTION - BOLZEN FÜR STURMLEISTE - VIS POUR LAME ANTI-TEMPETE			8	8x80	
GS	GABLE SEGMENT-DECKBLATT - LOSANGE DE FINITION			2		
	WASHER FOR STORM PROTECTION - DICHTSCHEIBE FÜR STURMLEISTE - RONDELLE POUR LAME ANTI-TEMPETE			8		
	SET OF DOOR LOCK COVERS - SCHLOSSBLENDEN - SET DE GARNITURES DE SERRURE DE PORTE			1		
	DOOR HANDLE FITTINGS-TÜRGRIFF - SET DE GARNITURES DE SERRURE DE PORTE			1		
	CYLINDER LOCK - ZYLINDERSCHLOSS - CYLINDRE DE SERRURE			1		
	POST HEIGHT ADJUSTMENT - REGULIERUNGSSCHRAUBE FÜR PFOSTEN - SUPPORT RÉGLABLE DE POTEAU			2		
	FLOWER BOX - BLUMENKASTEN - JARDINIERE			2		
	SHUTTERS - FENSTERLÄDEN - VOILETS DE FENETRE			2		
	WINDOW-FENSTER-FENETRE 882x882		AK.1.104.SSP.L SGC+W	2		
						
	DOOR-TÜR-PORTE 835x1957		UL.2.100.IVP.MML TC+W	1		
						

Pos	24.10.2014	FLOWER BOX - BLUMENKASTEN - JARDINIERE ART.NR. 990700	1/1	Q.	P (mm)	L (mm)
ES1				2	18x90	906
ES2				2	18x90	884
TS				2	18x140	846
PL				6	18x140	201
KL				4	18x140	200
SH100		ASSAMBLING SCREW FOR FLOWER BOX - SCHRAUBE ZUR BEFASTUGUNG DEN BLUMENKASTEN - VIS DE FIXATION AU MUR DES JARDINIERES 		56	3.5x50	
SH100		SCREW FOR FIXING FLOWER BOX TO THE WALLS - SCHRAUBE ZUR BEFASTUGUNG DEN BLUMENKASTEN - VIS DE FIXATION AU MUR DES JARDINIERES 		6	4x40	



- ①  4 pcs
- ②  8 pcs 4x40
- ③  3 pcs 3x30
- ④  2 pcs 100 mm
- ⑤-⑥  3 pcs 50 mm

