

4018211 207800

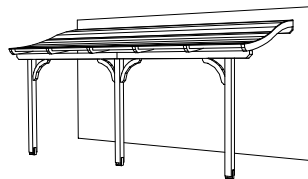

4018211 207824

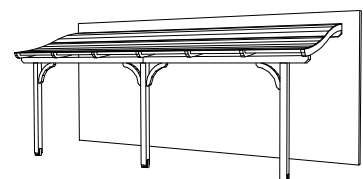

4018211 207848

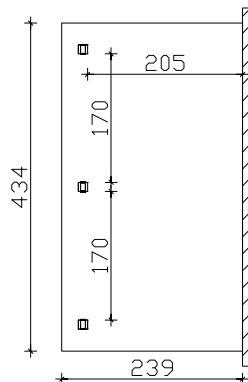

Grundriss

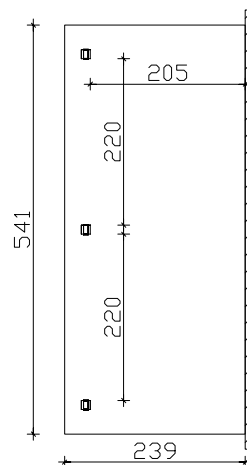

Grundriss

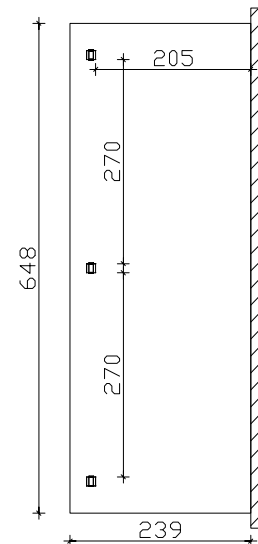

Grundriss

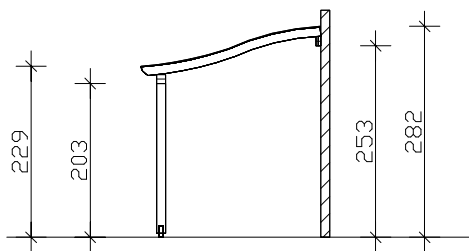

Seitenansicht

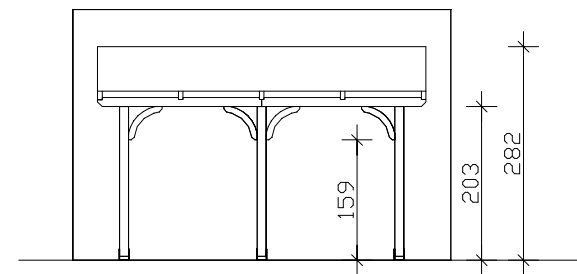

Frontansicht

M 1:100

"Venezia" Terrassenüberdachung 434cm / 541cm / 648cm x 239cm

Datenblatt / Baubeschreibung

Holzart / Eisenteile	Leimholz, unbehandelt / verzinkt
Pfosten	3 Stück 12x12x198cm
Dacheindeckung	Polycarbonat Doppelstegplatten 10mm (transparent)
Schneelast	sk = 2,00kN/m²
Breite x Tiefe	434cm / 541cm / 648cm x 239cm
Gesamthöhe / Durchgang	229-282cm / 203cm (inkl. Abstand zum Boden, Aufschraubstütze = 5cm)
Fläche (umb.Raum)	10,37m² (29,73m³) / 12,93m² (33,47m³) / 15,48m² (42,54m³)
Verpackungseinheit	BxLxH 110x266-340x40-45cm / Gewicht 240/275/305kg
Inklusive	Montagematerial, Aufschraubstützen, Kopfbänder, Aufbauanleitung (ohne Dübel für Wandbefestigung, ohne Wandabdichtungsprofile)

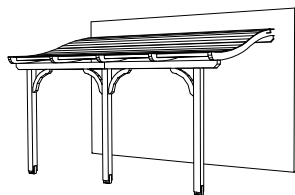

4018211 207862

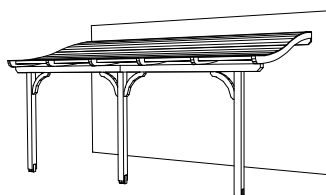

4018211 207886

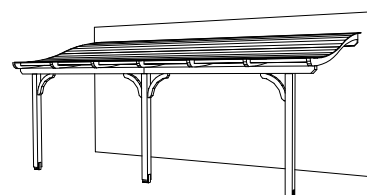

4018211 207916

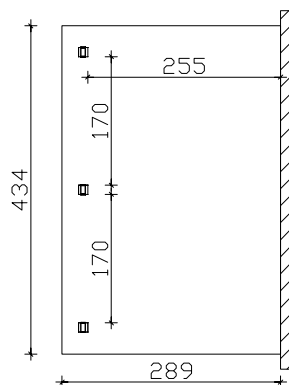

Grundriss

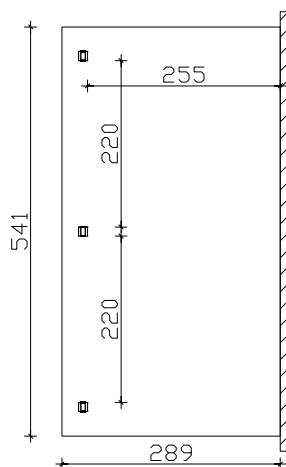

Grundriss

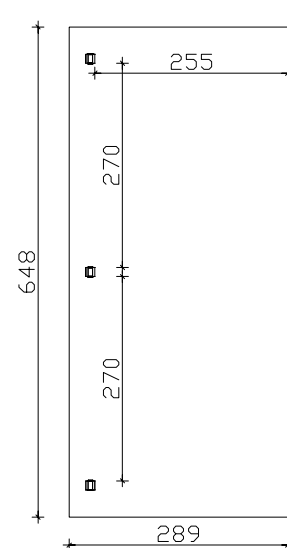

Grundriss

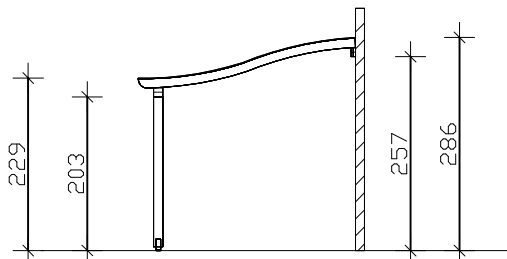

Seitenansicht

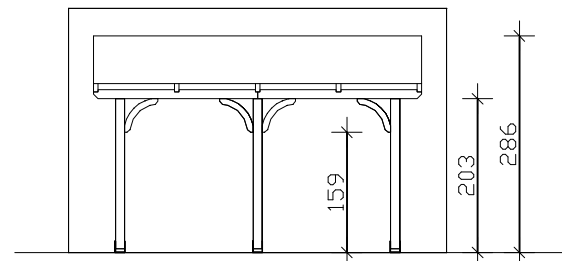

Fronansicht

M 1:100

"Venezia" Terrassenüberdachung 434cm / 541cm / 648cm x 289cm

Datenblatt / Baubeschreibung

Holzart / Eisenteile	Leimholz, unbehandelt / verzinkt
Pfosten	3 Stück 12x12x198cm
Dacheindeckung	Polycarbonat Doppelstegplatten 10mm (transparent)
Schneelast	sk = 1,60kN/m²
Breite x Tiefe	434cm / 541cm / 648cm x 289cm
Gesamthöhe / Durchgang	229-286cm / 203cm (inkl. Abstand zum Boden, Aufschraubstütze = 5cm)
Fläche (umb.Raum)	12,54m² (33,47m³) / 15,63m² (37,21m³) / 18,72m² (46,28m³)
Verpackungseinheit	BxLxH 110x317-330x38-45cm / Gewicht 250/290/320kg
Inklusive	Montagematerial, Aufschraubstützen, Kopfbänder, Aufbauanleitung (ohne Dübel für Wandbefestigung, ohne Wandabdichtungsprofile)

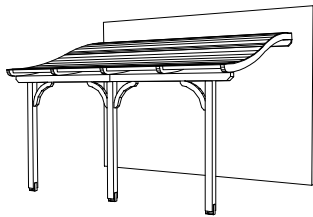

4018211 207930

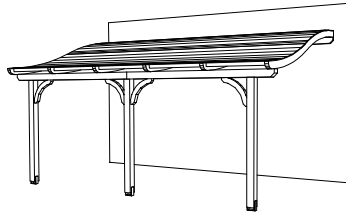

4018211 207954

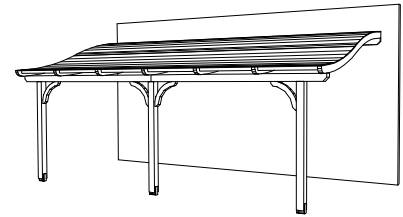

4018211 207978

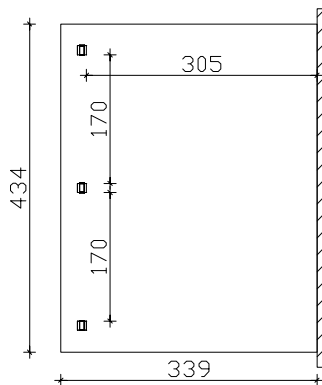

Grundriss

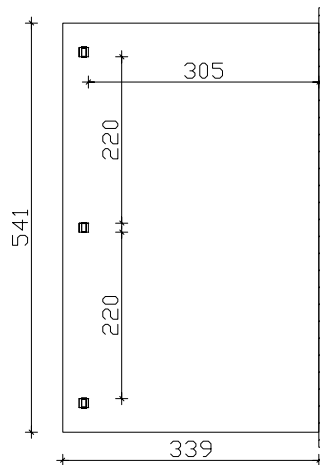

Grundriss

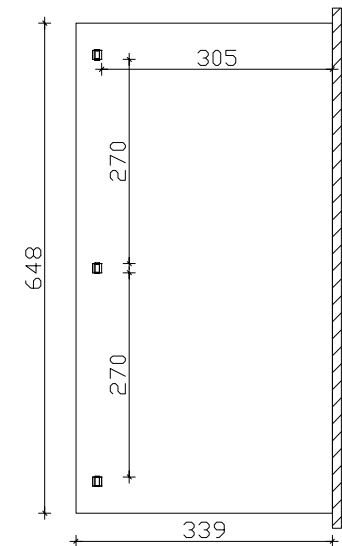

Grundriss

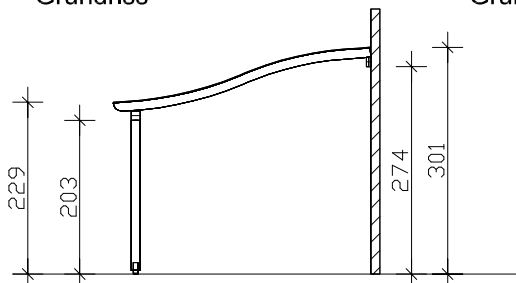

Seitenansicht

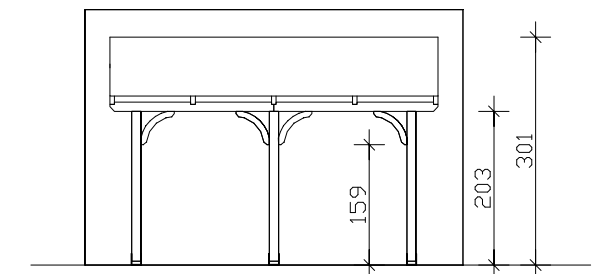

Frontansicht

M 1:100

"Venezia" Terrassenüberdachung 434cm / 541cm / 648cm x 339cm

Datenblatt / Baubeschreibung

Holzart / Eisenteile	Leimholz, unbehandelt / verzinkt
Pfosten	3 Stück 12x12x198cm
Dacheindeckung	Polycarbonat Doppelstegplatten 10mm (transparent)
Schneelast	sk = 1,35kN/m²
Breite x Tiefe	434cm / 541cm / 648cm x 339cm
Gesamthöhe / Durchgang	229-301cm / 203cm (inkl. Abstand zum Boden, Aufschraubstütze = 5cm)
Fläche (umb.Raum)	14,71m² (41,03m³) / 18,33m² (50,23m³) / 21,97m² (59,42m³)
Verpackungseinheit	BxLxH 110x366x38-46cm / Gewicht 260/300/335kg
Inklusive	Montagematerial, Aufschraubstützen, Kopfbänder, Aufbauanleitung (ohne Dübel für Wandbefestigung, ohne Wandabdichtungsprofile)

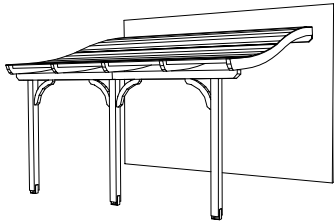

4018211 207992

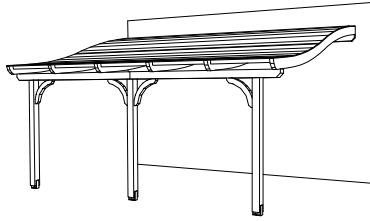

4018211 208012

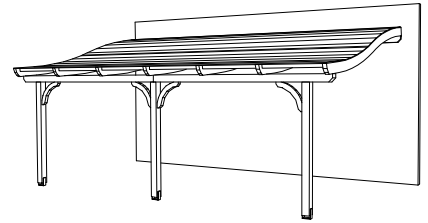

4018211 208036

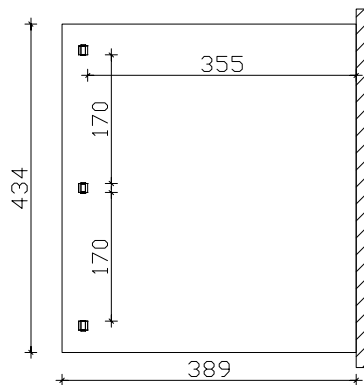

Grundriss

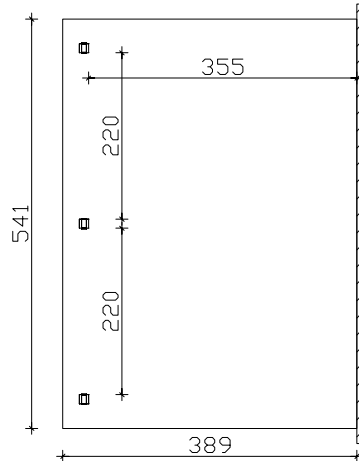

Grundriss

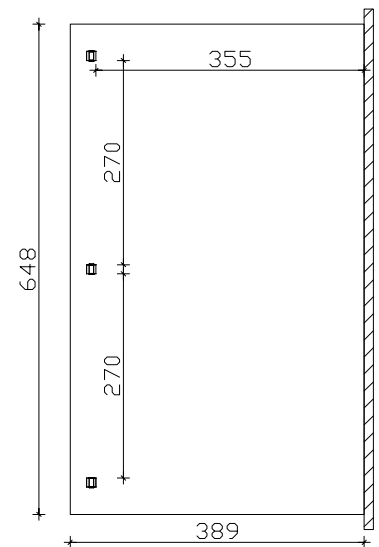

Grundriss

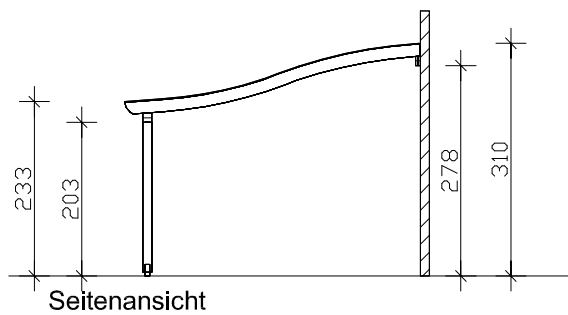

Seitenansicht

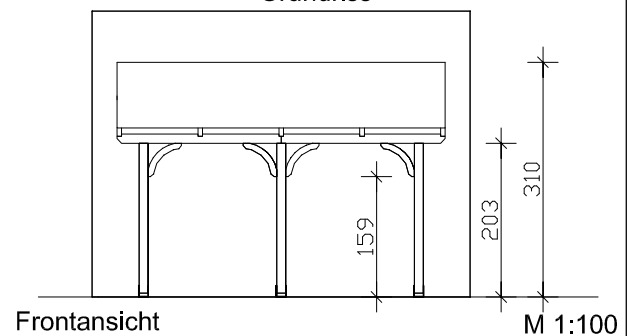

Frontansicht

M 1:100

"Venezia" Terrassenüberdachung 434cm / 541cm / 648cm x 389cm

Datenblatt / Baubeschreibung

Holzart / Eisenteile	Leimholz, unbehandelt / verzinkt
Pfosten	3 Stück 12x12x198cm
Dacheindeckung	Polycarbonat Doppelstegplatten 10mm (transparent)
Schneelast	sk = 1,45kN/m²
Breite x Tiefe	434cm / 541cm / 648cm x 389cm
Gesamthöhe / Durchgang	233-310cm / 203cm (inkl. Abstand zum Boden, Aufschraubstütze = 5cm)
Fläche (umb.Raum)	16,88m² (44,77m³) / 21,04m² (53,97m³) / 25,21m² (63,16m³)
Verpackungseinheit	BxLxH 110x415x40-45cm / Gewicht 310/355/400kg
Inklusive	Montagematerial, Aufschraubstützen, Kopfbänder, Aufbauanleitung (ohne Dübel für Wandbefestigung, ohne Wandabdichtungsprofile)