

# Technische Daten Monika 34-A

Wandaußenmaß: 300 x 240 cm

Bohlenstärke: 34 mm



Monika 34-B, durch Kunden farblich endbehandelt

Kontrolliert durch:

Achtung: Alle angegebenen Maße sind ca.-Maße!

# 3D-Darstellung Monika 34-A

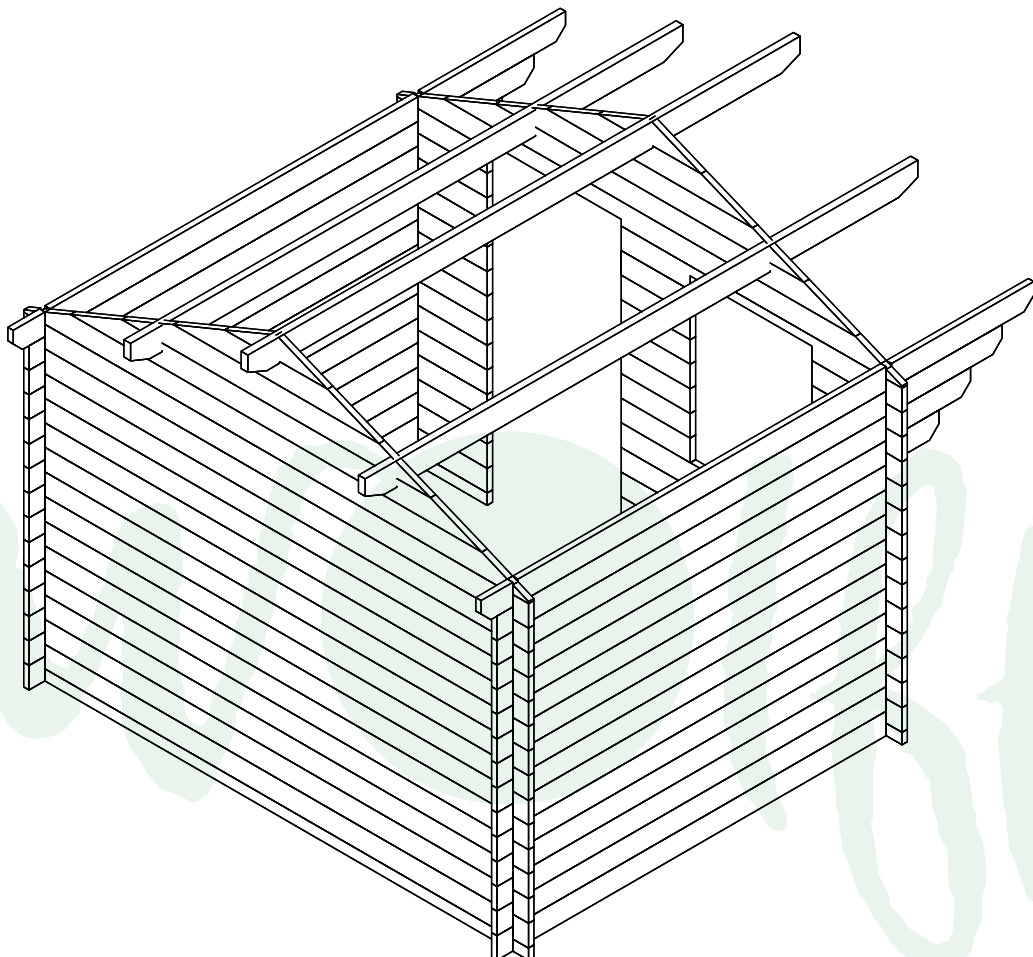
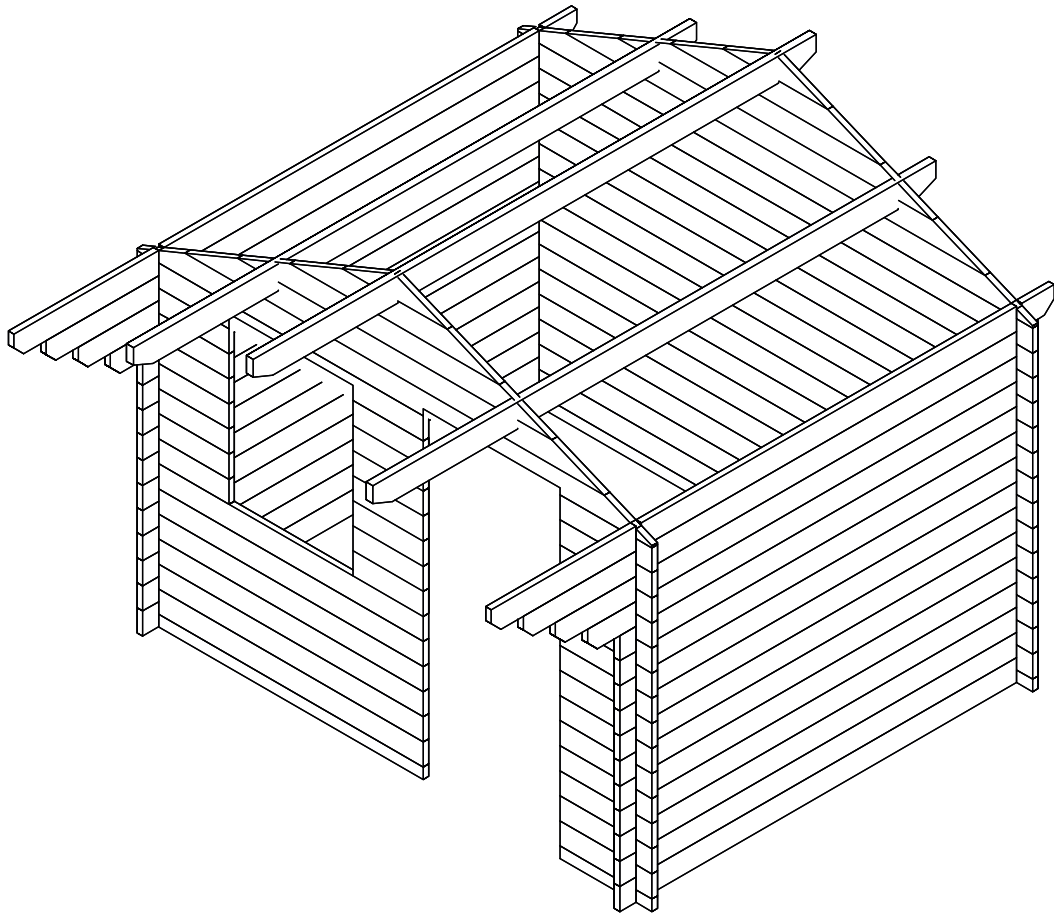

# Grundriss und Lagerholzplan Monika 34-A

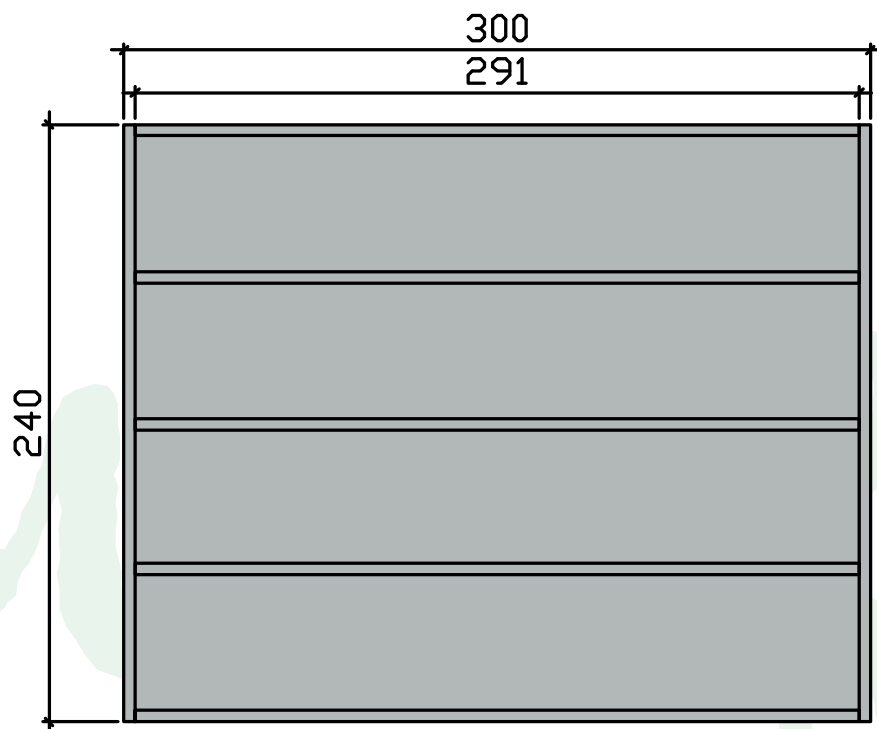
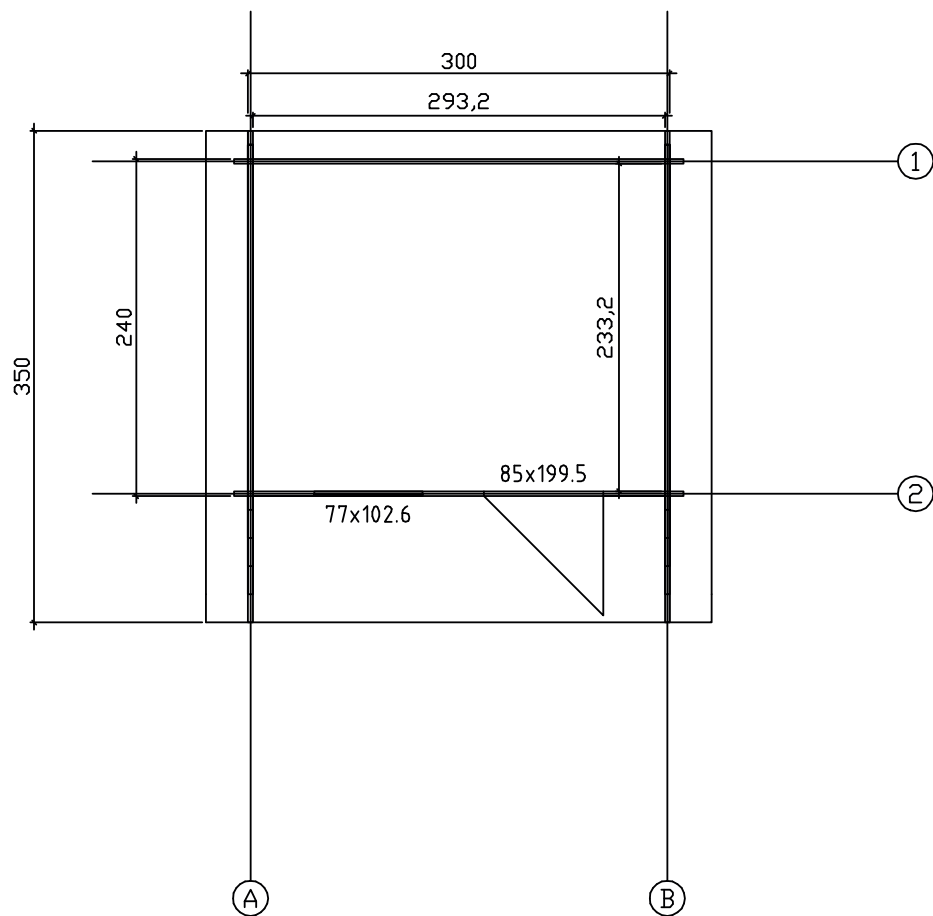

# Fundamentplan Monika 34-A



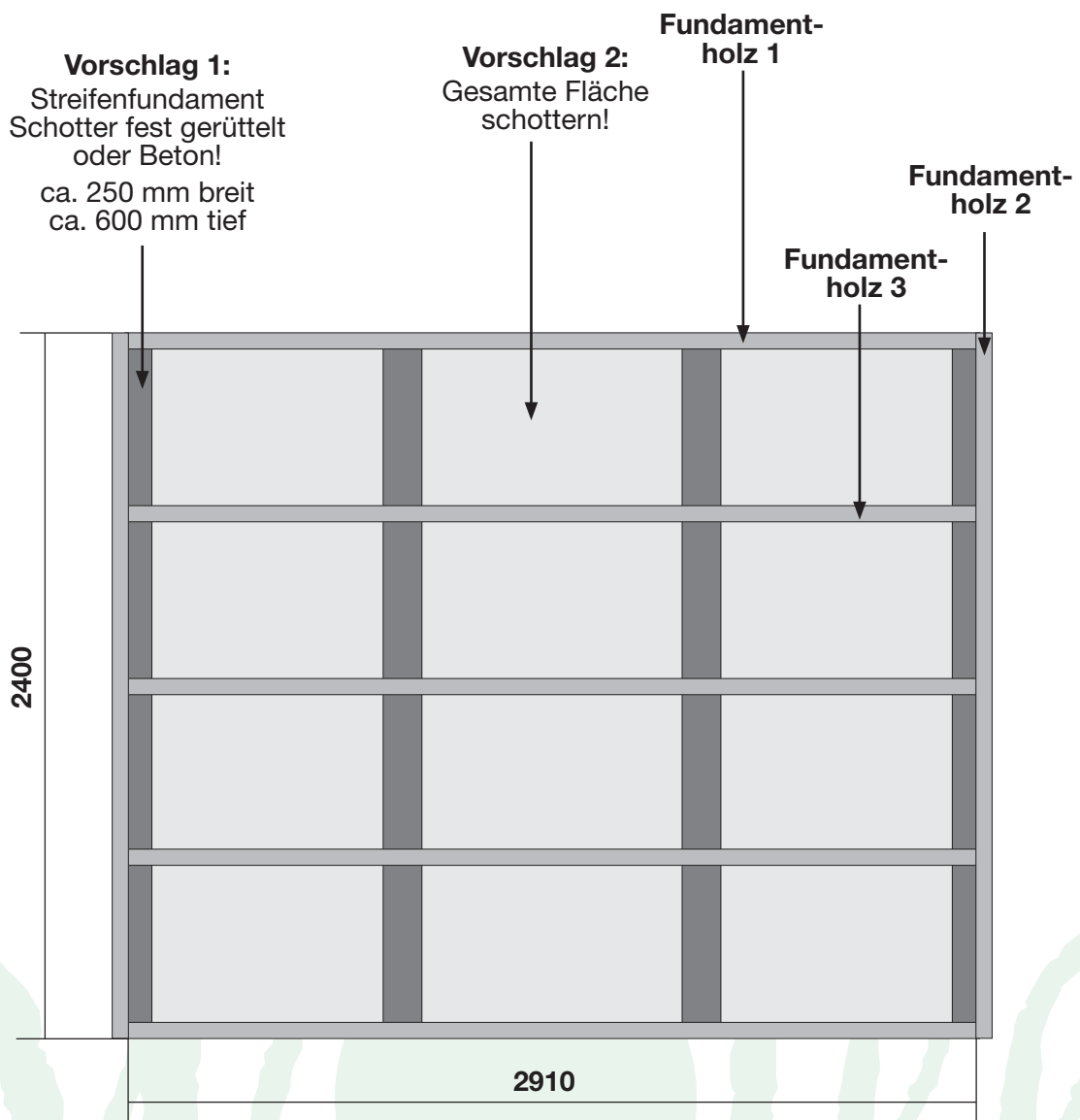







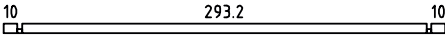
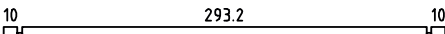
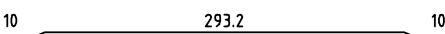
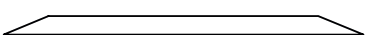



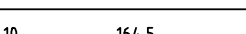

Haustyp	Anzahl der Fundamenthölzer (B x H x L)
Monika 34-A	Fundamentholz 1: 2 (45 x 70 x 2910 mm) Fundamentholz 2: 2 (45 x 70 x 2400 mm) Fundamentholz 3: 3 (45 x 70 x 2910 mm)

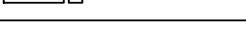

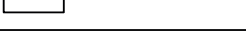
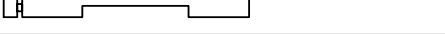
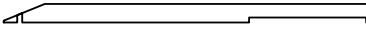
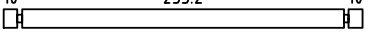
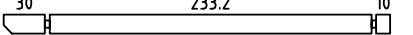
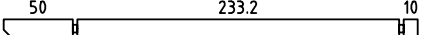
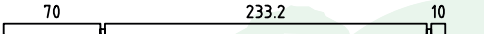
**Dieser Fundamentplan ist ein unverbindlicher Vorschlag und kann individuell verändert werden!**



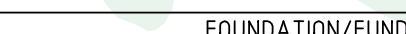







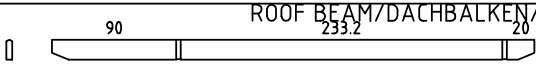



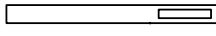

# Teileliste 1

## Monika 34-A

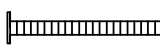
Pos		Stück	Profile (cm)	Länge (cm)
001		1	3.4x6.8	320
002		14	3.4x13.5	320
003		1	3.4x13.5	320
004		2	3.4x13.5	260.6
005		2	3.4x13.5	195.5
006		2	3.4x13.5	130.3
007		2	3.4x13.5	65.2
008		1	3.4x6.8	177.9
009		1	3.4x6.8	57.1
010		5	3.4x13.5	177.9
011		21	3.4x13.5	57.1
012		1	3.4x13.5	177.9
013		7	3.4x13.5	43.7
014		1	3.4x13.5	177.9
015		1	3.4x13.5	320
016		22	3.4x13.5	260
017		2	3.4x13.5	280
018		2	3.4x13.5	300
019		2	3.4x13.5	320
020		1	3.4x13.5	350
021		1	3.4x13.5	350
AR2	FOUNDATION/FUNDAMENT/SOLIVE 	2	4.5x7	291
AR1	FOUNDATION/FUNDAMENT/SOLIVE 	2	4.5x7	240
PT1	FOUNDATION/FUNDAMENT/SOLIVE 	3	4.5x7	291
PR1	ROOF BEAM/DACHBALKEN/PANNE 	2	4.3x14.5	350

# Teileliste 2

## Monika 34-A

Pos		Stück	Profile (cm)	Länge (cm)
PR2		1	4.3x14.5	350
	WINDOW 77x102.6	1		
	DOOR 85x199.5	1		
022	FLOOR BOARDS/FUSSBODEN/LAME DE PLANCHER 	26	11.2x1.8	232.0
023	ROOF BOARDS/DACHBRETTER/VOLIGE 	64	11.2x1.8	189.5
024	ROOF EDGE REINFORCEMENT/TRAUFENLEISTE/TASSEAU 	2	2.6x3.2	350.0
025	PULLER/STURMLEISTEN/GARNITURE SLAT 	4	2.6x3.2	200.0
026	ROOF SIDE BOARDS/TRAUFENBRETT/PLANCHE DE RIVE 	2	1.8x9	350.0
027	FASCIA BOARD/GIEBELBLENDE/PLANCHE DE RIVE (FACADE) 	4	1.8x12.0	195.0
028	FASCIA BOARD/GIEBELBLENDE/PLANCHE DE RIVE (FACADE) 	4	1.8x6.0	195.0
029	FLOOR EDGE TRIM/FUßLEISTEN/PLINTHE PLANCHER 	2	2.0x4.5	233.0
030	FLOOR EDGE TRIM/FUßLEISTEN/PLINTHE PLANCHER 	2	2.0x4.5	293.0
031	DIAMOND/RAUTE/DIAMANT 	2	1.8x12	120
032	BOLT/BOLZEN/BOULON 	8	M8	80
033	Shim, Nut/Mutter, M8 mm - For fixing storm braces/Pour fixer les anti-tempete/Für Sturmleisten 	8	M8	
034	Nails/Nägel/Clous 2.5 x 50 mm - For fixing roofboards Befestigung Dachbretter/P our fixer les voliges 	500		
035	Nails/Nägel/Clous 2.0 40 mm - For fixing roofing felt fillet (18 x 90 mm)/ Befestigung Giebelabschlußbrett (18 x 90 mm)/ Pour fixer la latte de finition de la couverture (18 x 90 mm) 	24		
036	Screws/Schrauben/Vis 4 x 50 mm - For fixing roof side boards and roof edge reinforcement/Befestigung Traufenbretter und Traufenleisten Pour fixer les planches de rive et le tasseau (30 x 34 mm) de renfort 	60		
037	Screws/Schrauben/Vis 2.5X25 mm - For fixing window and door trims/ Befestigung Fenster und Türen/P our fixer les croisillons des fenetres et des portes 	30		
038	Nails/Nägel/Clous 1.4 x 40 mm - For fixing floor edge trims (19 x 19 mm)/ Befestigung Fußleisten/Pour fixer les plinthes du plancher (19 x 19 mm) 	20		

# Wandpläne 1 Monika 34-A

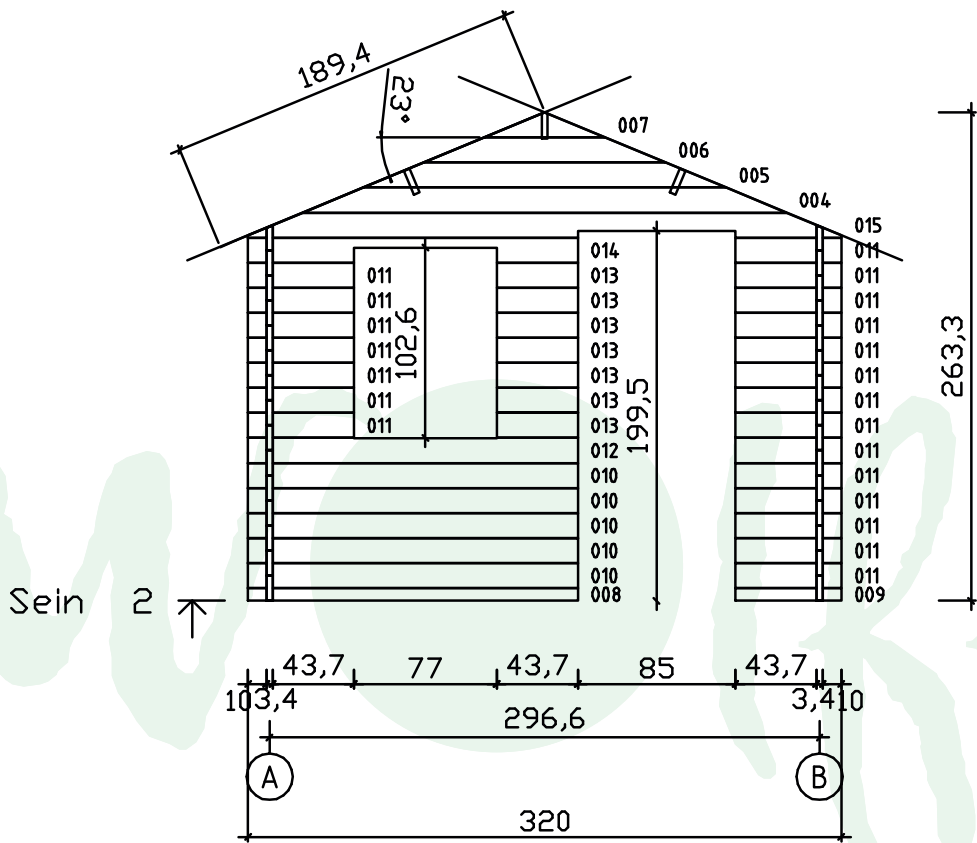
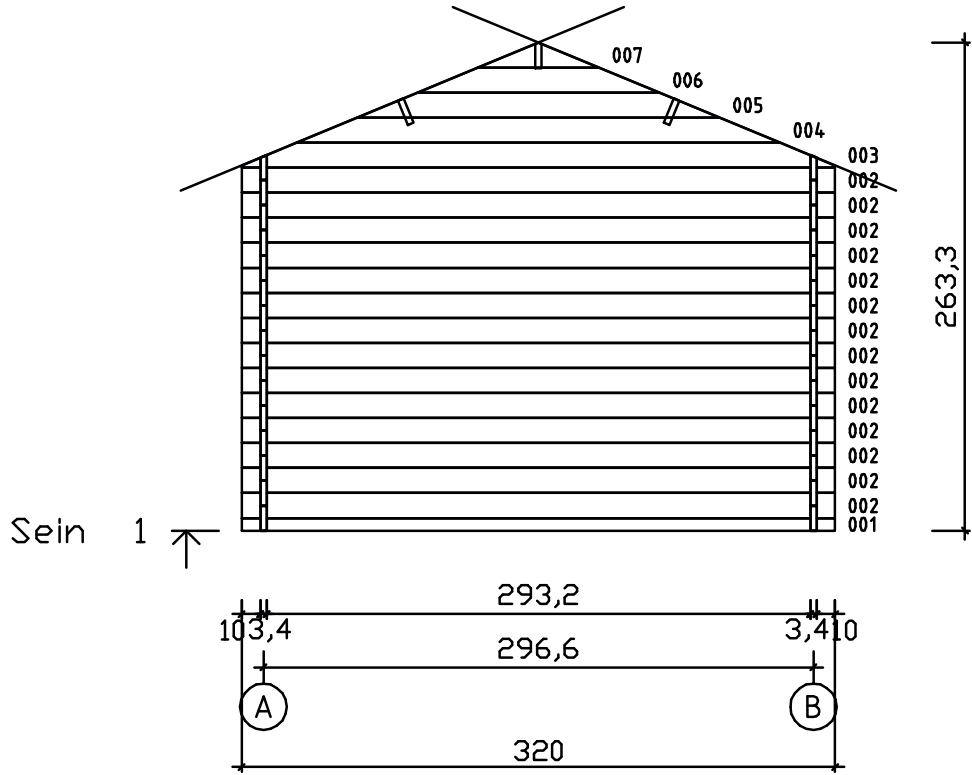

# Wandpläne 2 Monika 34-A

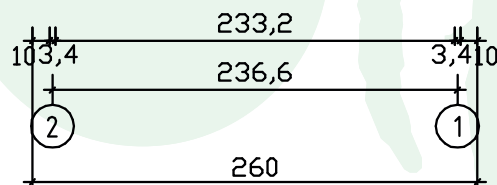
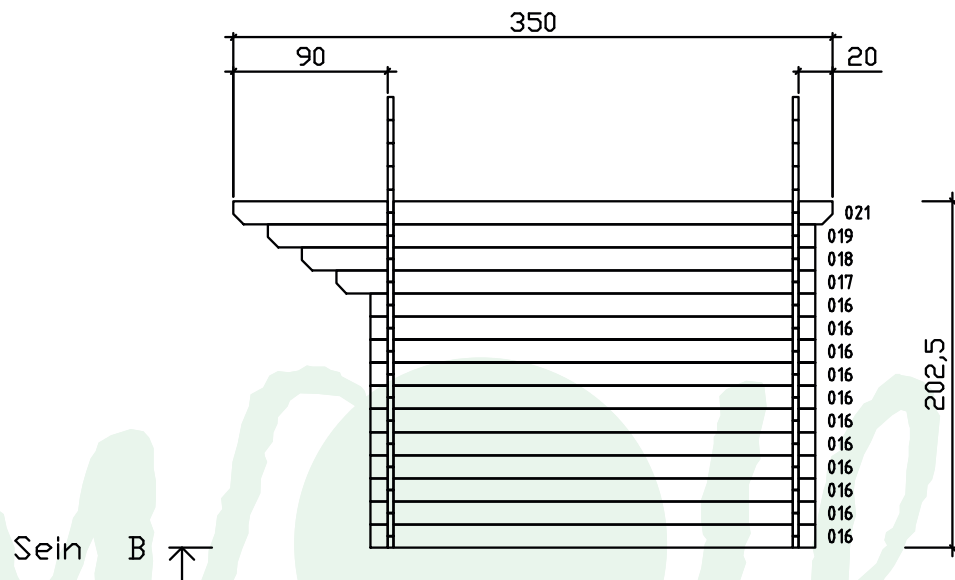
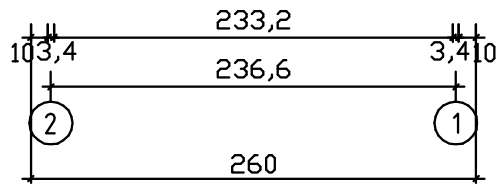
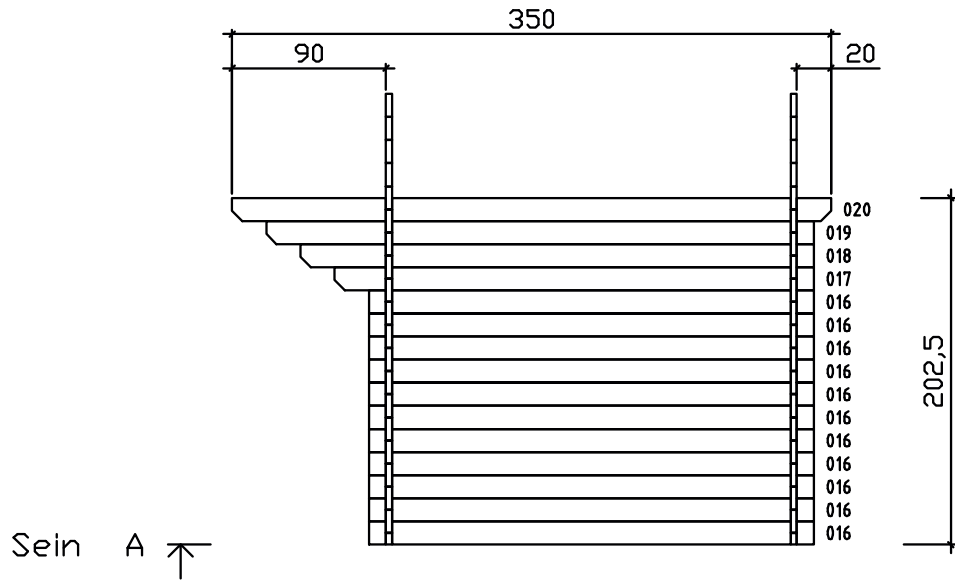



# Detail Monika 34-A

