

Caro 34 Klassik / Modern

Wandaußenmaß: 450 x 300 cm

Bohlenstärke: 34 mm



Kontrolliert durch:

Achtung: Alle angegebenen Maße sind ca.-Maße!

3D-Darstellung und Grundriss Caro 34 Klassik / Modern

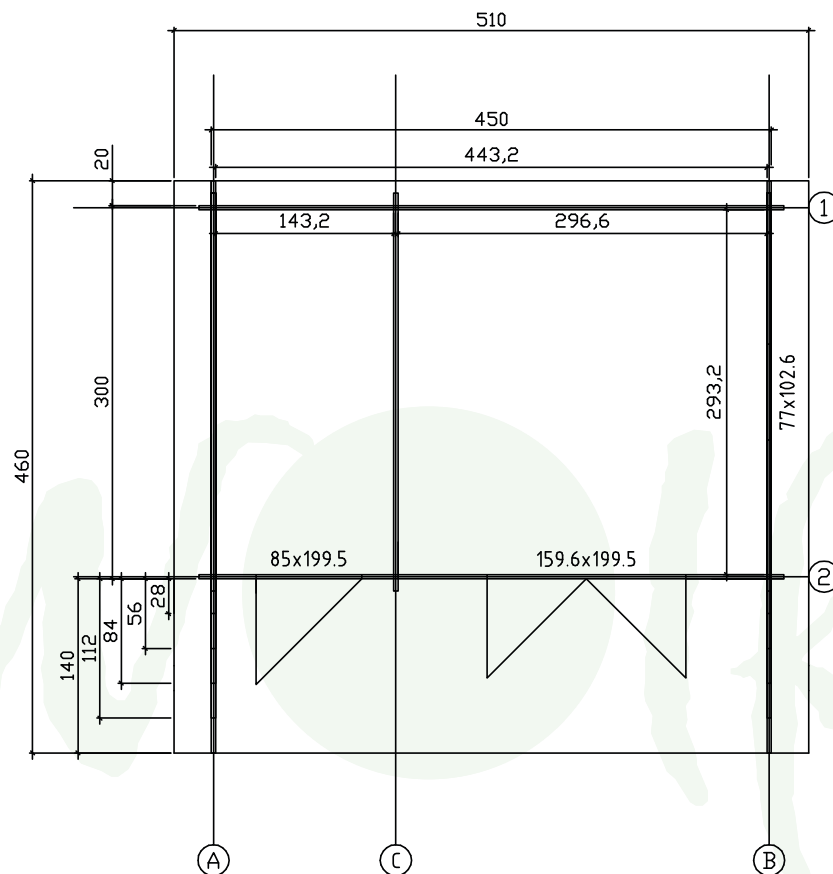
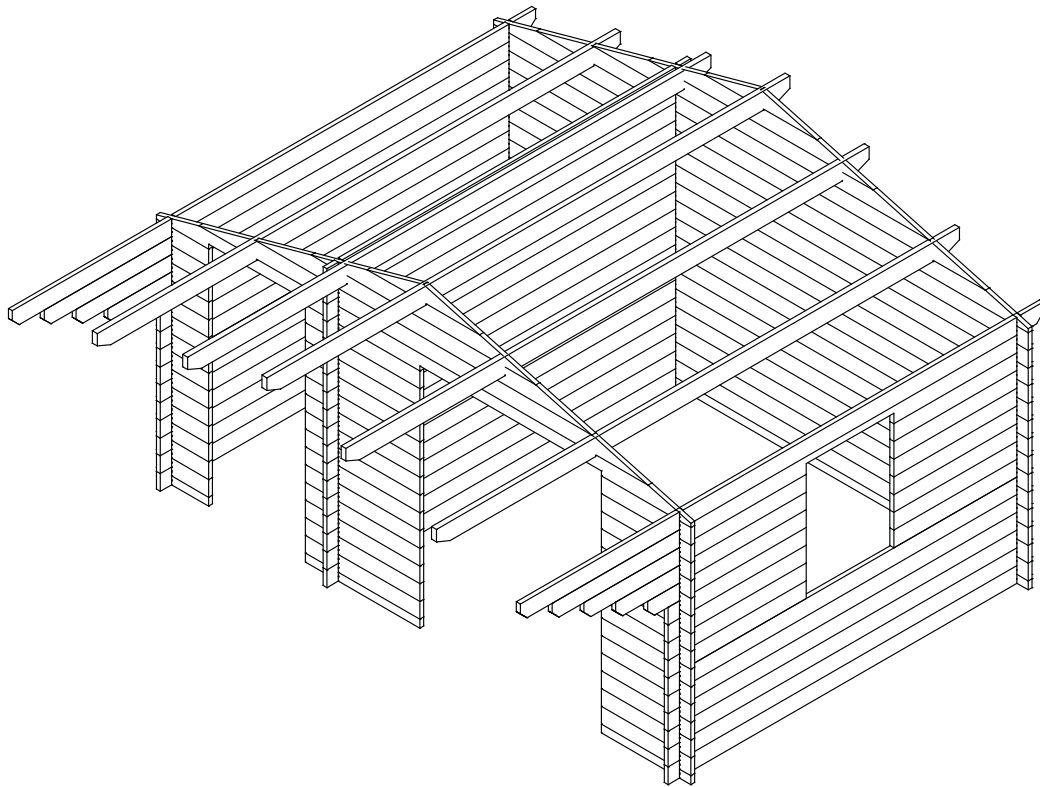





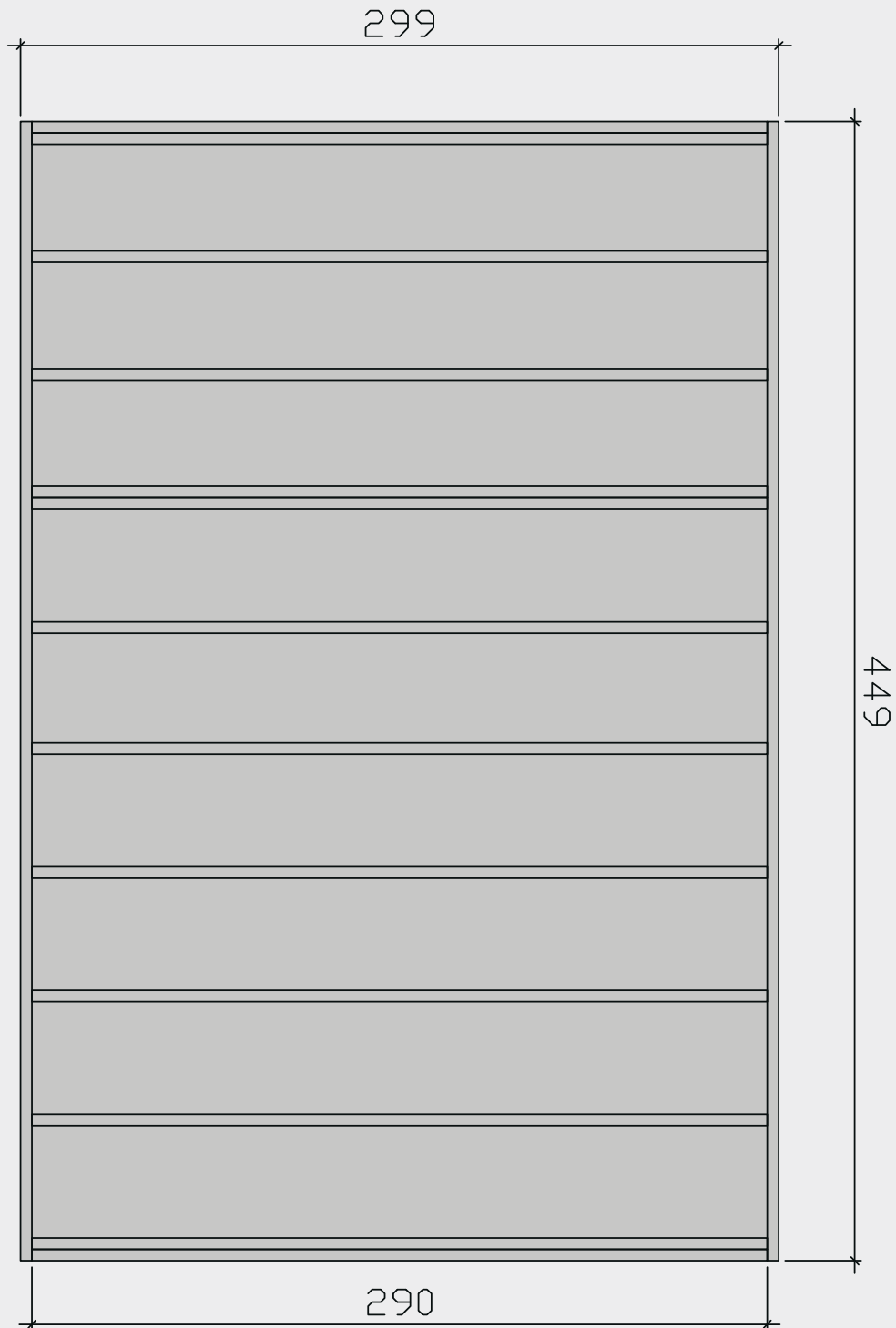





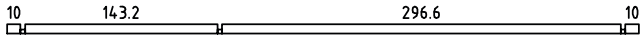
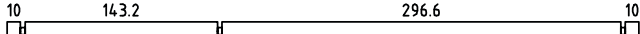

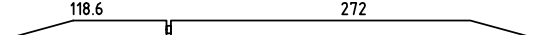
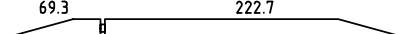
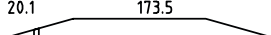
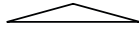

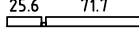
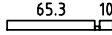
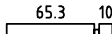
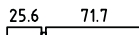
Lagerholzplan und Fundamentplan Caro 34 Klassik / Modern

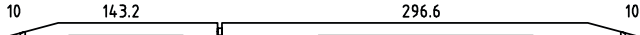
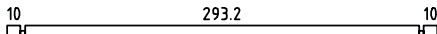
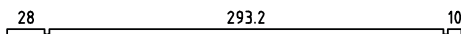
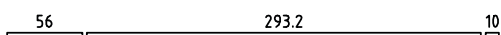
Wir empfehlen als Fundament für Ihr Gartenhaus eine vollflächig, festgegründete gepflasterte oder betonierte Fläche. Wahlweise ist auch ein Punkt- oder Streifenfundament möglich.



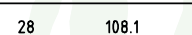







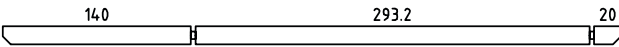
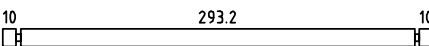
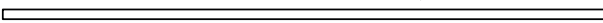
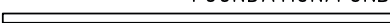
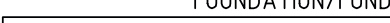
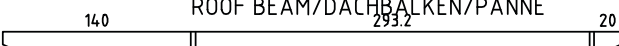
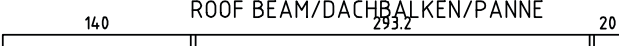

Teileliste 1

Caro 34 Klassik / Modern

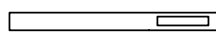
Pos		Stück	Profile (cm)	Länge (cm)
001		1	3.4x6.8	470
002		14	3.4x13.5	470
003		1	3.4x13.5	470
004		2	3.4x13.5	394
005		2	3.4x13.5	295.5
006		2	3.4x13.5	197
007		2	3.4x13.5	98.5
008		1	3.4x6.8	46
009		1	3.4x6.8	100.7
010		1	3.4x6.8	78.7
011		14	3.4x13.5	46
012		14	3.4x13.5	100.7
013		14	3.4x13.5	78.7
014		1	3.4x13.5	470
015		33	3.4x13.5	320
016		1	3.4x13.5	338
017		1	3.4x13.5	366
018		1	3.4x13.5	394
019		1	3.4x13.5	422
020		1	3.4x13.5	460
021		11	3.4x13.5	121.5
022		1	3.4x13.5	139.5
023		1	3.4x13.5	167.5
024		1	3.4x13.5	195.5
025		1	3.4x13.5	422

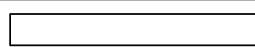
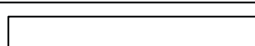





Teileliste 2

Caro 34 Klassik / Modern

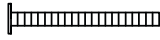
Pos		Stück	Profile (cm)	Länge (cm)
026		1	3.4x13.5	460
027		1	3.4x13.2	320
AR2	FOUNDATION/FUNDAMENT/SOLIVE 	2	4.5x7	449
AR1	FOUNDATION/FUNDAMENT/SOLIVE 	2	4.5x7	290
PT1	FOUNDATION/FUNDAMENT/SOLIVE 	11	4.5x7	290
PR1	ROOF BEAM/DACHBALKEN/PANNE 	4	4.3x14.5	460
PR2	ROOF BEAM/DACHBALKEN/PANNE 	1	4.3x14.5	460
	WINDOW/FENSTER 77x102.6	1		
	DOOR/TÜR 159.6x199.5 <u>Klassik: Hero (half glass/Halbglas)</u> double door/Doppeltür <u>Modern: Lars (full glass/Vollglas)</u>	1		
	DOOR/TÜR 85x199.5 <u>Klassik: Finn (half glass/Halbglas)</u> single door/Einzeltür <u>Modern: Nils (full glass/Vollglas)</u>	1		
028	FLOOR BOARDS/FUSSBODEN/LAME DE PLANCHER 	27	11.2x1.8	295.8
029	FLOOR BOARDS/FUSSBODEN/LAME DE PLANCHER 	27	11.2x1.8	142.4
030	ROOF BOARDS/DACHBRETTER/VOLIGE 	82	11.2x1.8	251.5
031	ROOF EDGE REINFORCEMENT/TRAUFENLEISTE/TASSEAU 	2	2.6x3.2	460.0
032	PULLER/STURMLEISTEN/GARNITURE SLAT 	4	2.6x3.2	200.0
033	ROOF SIDE BOARDS/TRAUFENBRETT/PLANCHE DE RIVE 	2	1.8x9	460.0
034	FASCIA BOARD/GIEBELBLENDE/PLANCHE DE RIVE (FACADE) 	4	1.8x12.0	257.1
035	FASCIA BOARD/GIEBELBLENDE/PLANCHE DE RIVE (FACADE) 	4	1.8x6.0	257.1
036	FLOOR EDGE TRIM/FUßLEISTEN/PLINTHE PLANCHER 	2	2.0x4.5	443.0
037	FLOOR EDGE TRIM/FUßLEISTEN/PLINTHE PLANCHER 	2	2.0x4.5	443.0
038	DIAMOND/RAUTE/DIAMANT 	2	1.8x12	120

Teileliste 3

Caro 34 Klassik / Modern

Pos		Stück	Profile (cm)	Länge (cm)
039	BOLT/BOLZEN/BOULON 	8	M8	
040	Shim, Nut/Mutter, M8 mm - For fixing storm braces/Pour fixer les anti-tempete/Für Sturmleisten 	8	M8	
041	Nails/Nägel/Clous 2.5 x 50 mm - For fixing roofboards Befestigung Dachbretter/P our fixer les voliges 	500		
042	Nails/Nägel/Clous 2.0 40 mm - For fixing roofing felt fillet (18 x 90 mm)/ Befestigung Giebelabschlusfbrett (18 x 90 mm)/ Pour fixer la latte de finition de la couverture (18 x 90 mm) 	24		
043	Screws/Schrauben/Vis 4 x 50 mm - For fixing roof side boards and roof edge reinforcement/Befestigung Traufenbretter und Traufenleisten Pour fixer les planches de rive et le tasseau (30 x 34 mm) de renfort 	60		
044	Screws/Schrauben/Vis 2.5X25 mm - For fixing window and door trims/ Befestigung Fenster und Türen/P our fixer les croisillons des fenetres et des portes 	30		
045	Nails/Nägel/Clous 1.4 x 40 mm - For fixing floor edge trims (19 x 19 mm)/ Befestigung Fußleisten/Pour fixer les plinthes du plancher (19 x 19 mm) 	20		

Wandplan 1 und 2 Caro 34 Klassik / Modern

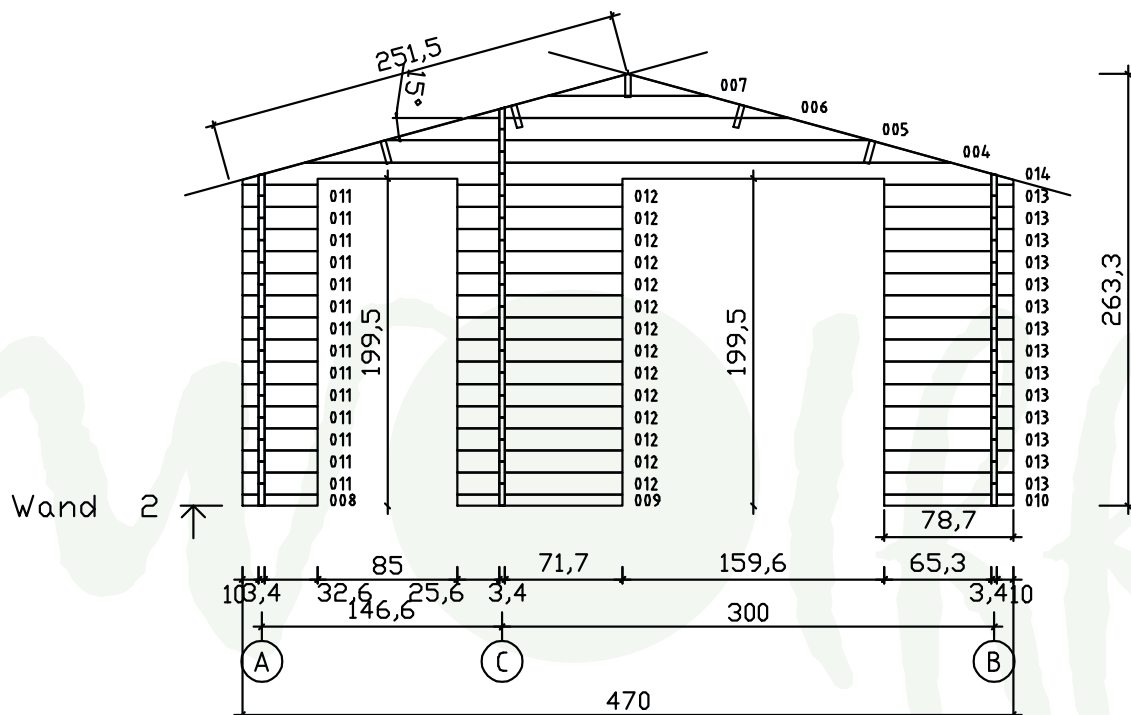
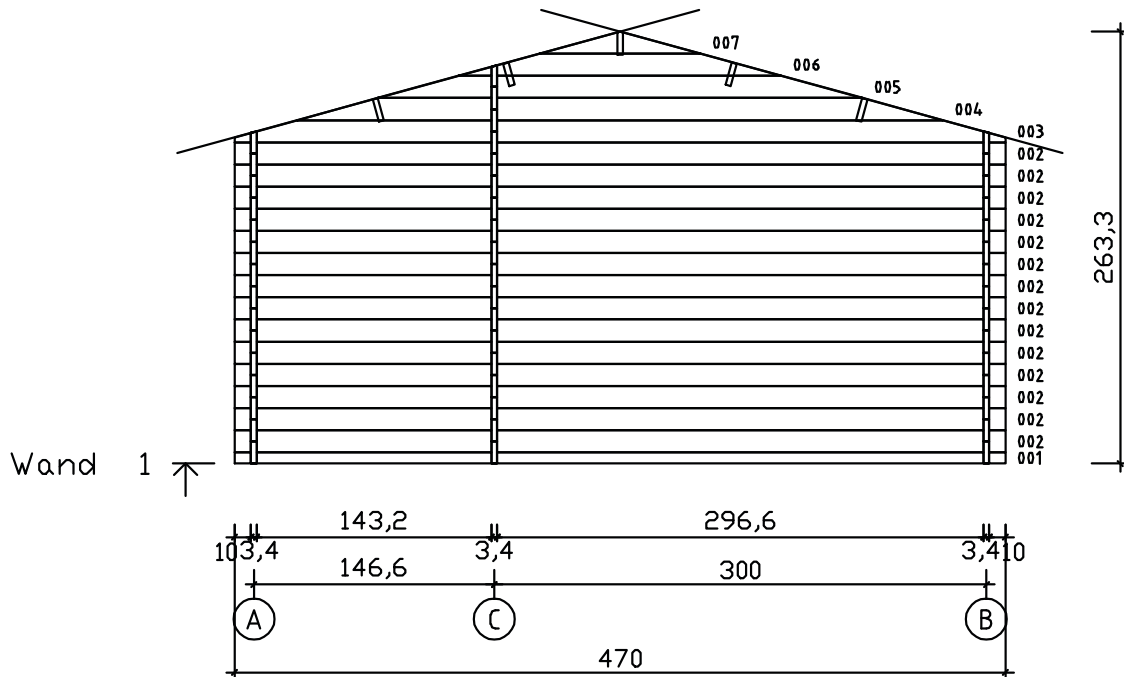

Wandplan A und B Caro 34 Klassik / Modern

Wand A ↗

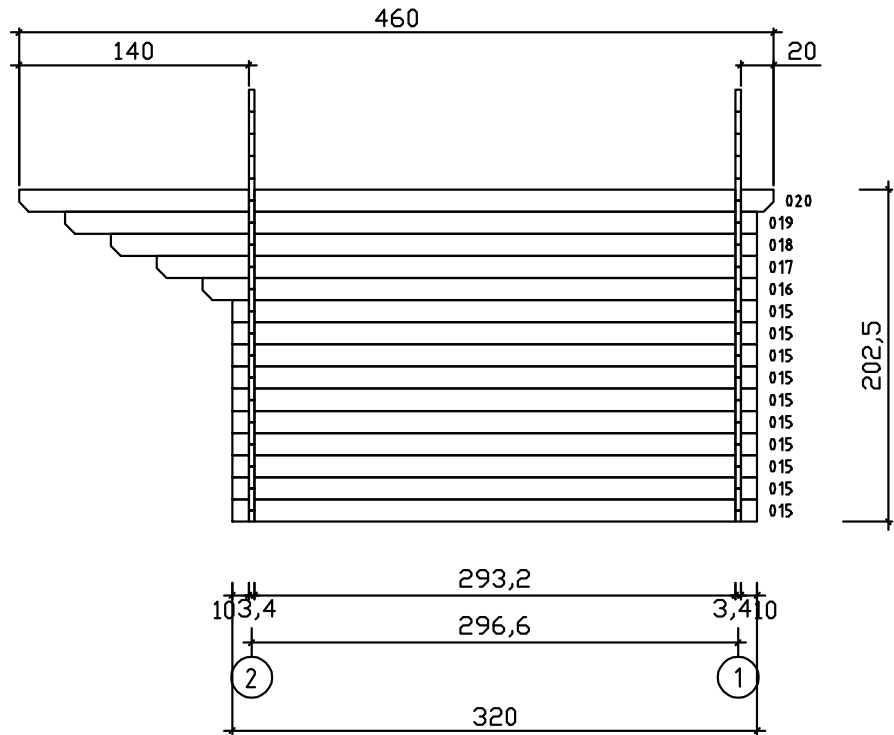

Wand B ↗

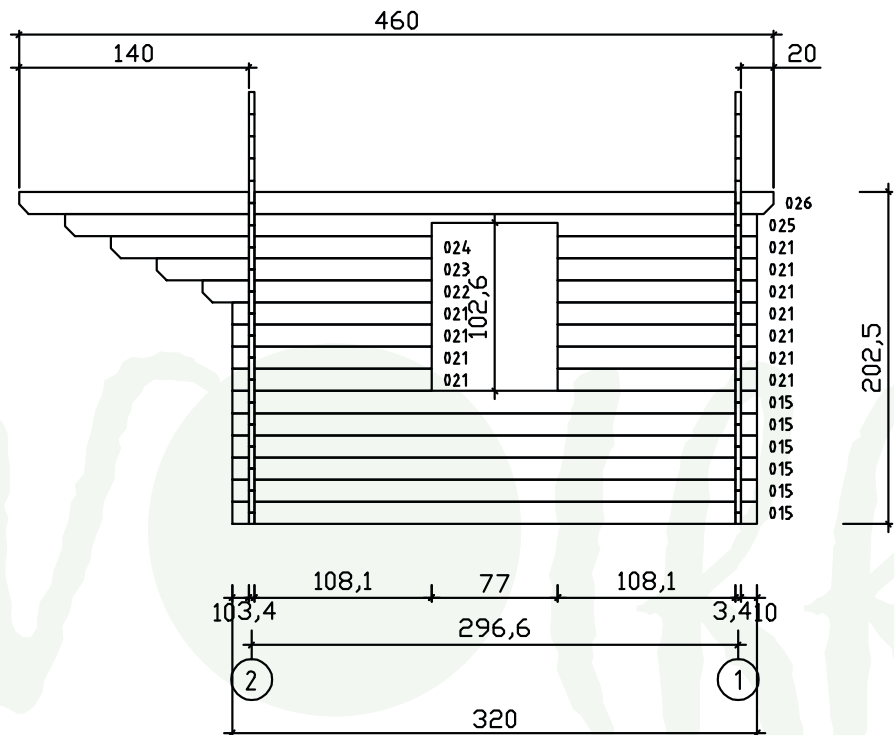

Wandplan C

Caro 34 Klassik / Modern

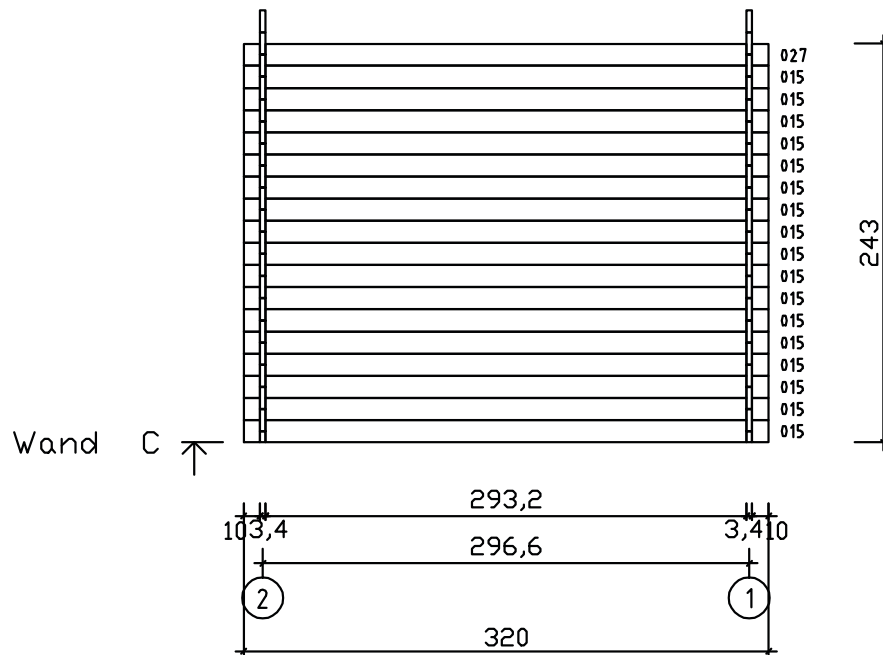

Detail

Caro 34 Klassik / Modern

