

# Korpus für Cordoba/Malaga 44-B Modern



Kontrolliert durch:

Achtung: Alle angegebenen Maße sind ca.-Maße!

# 3D-Darstellung und Grundriss Korpus für Cordoba/Malaga 44-B Modern

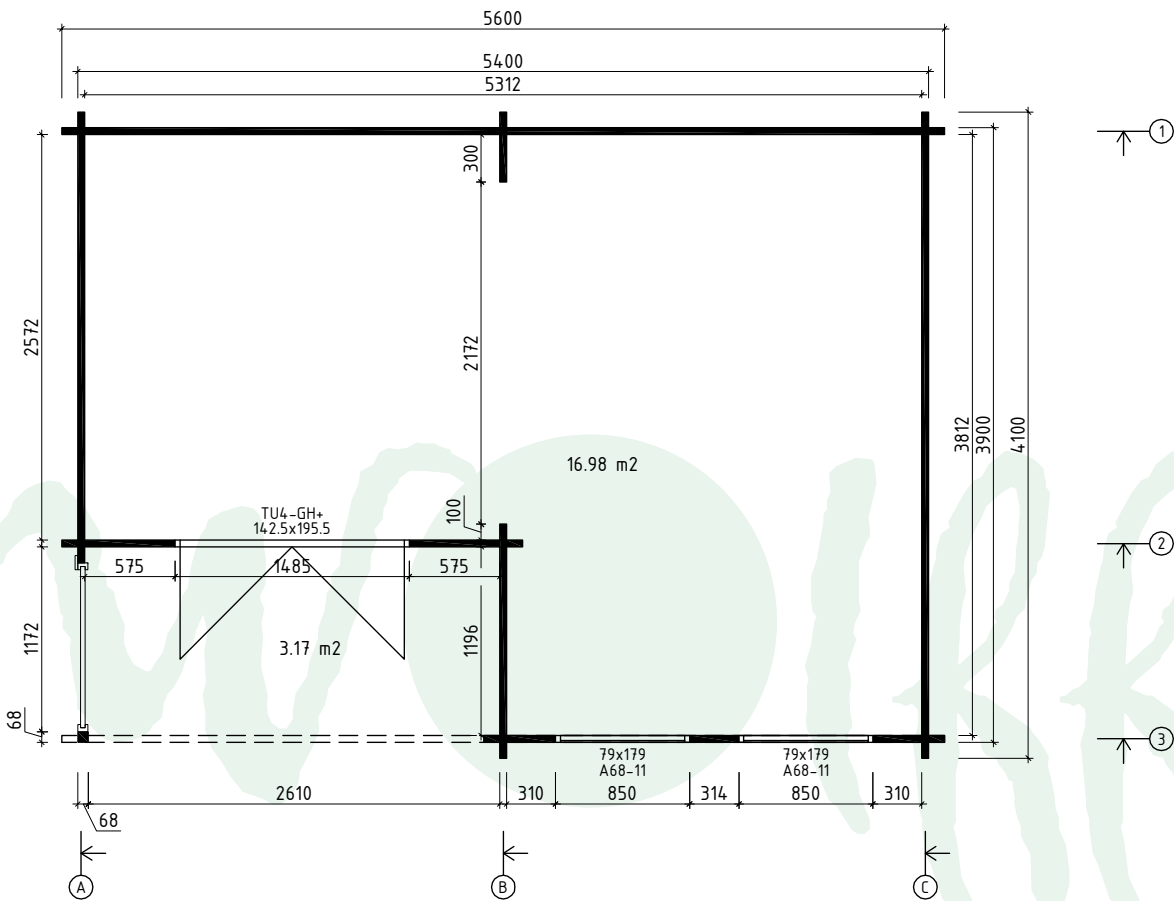
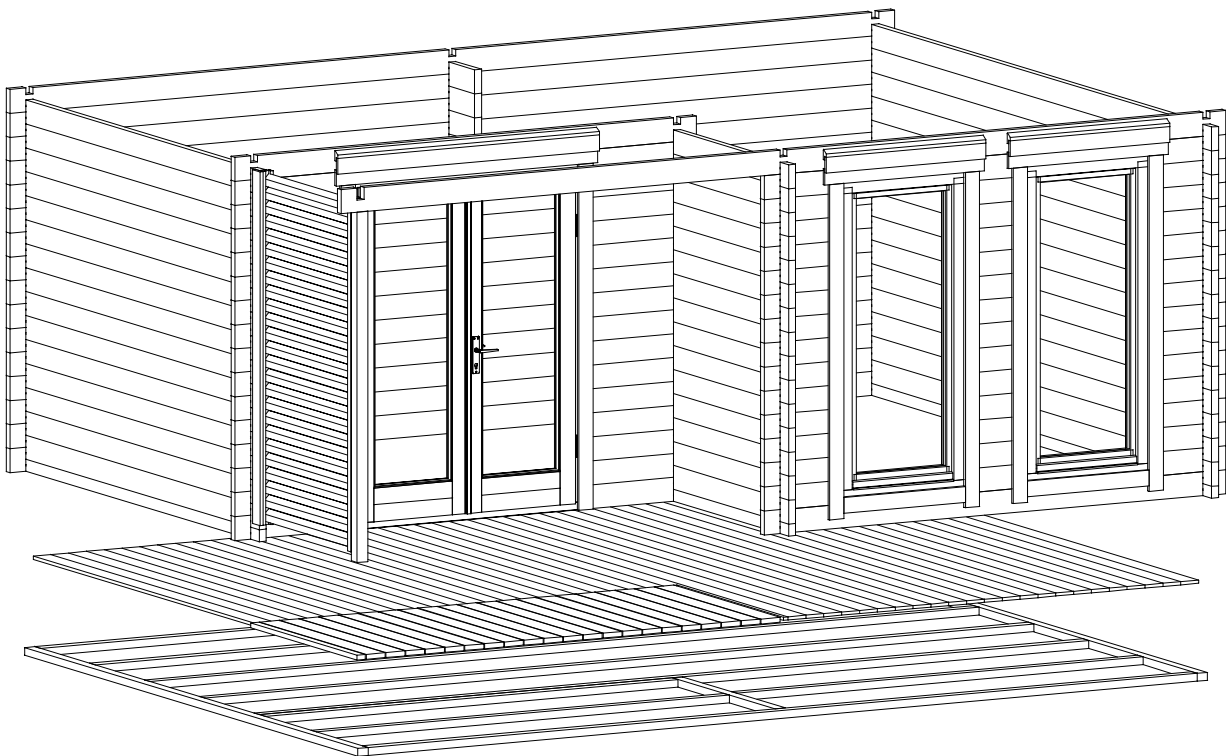





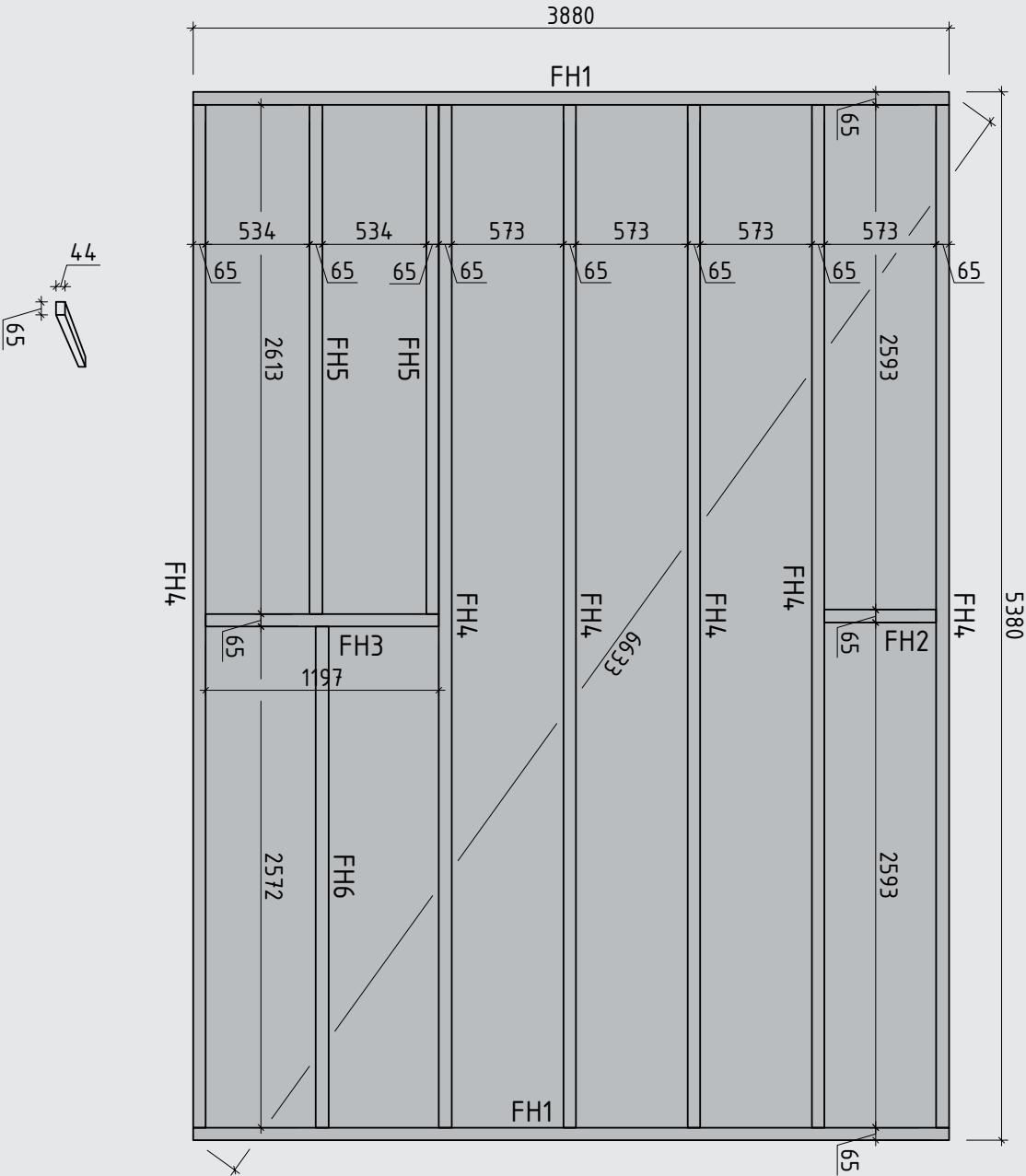





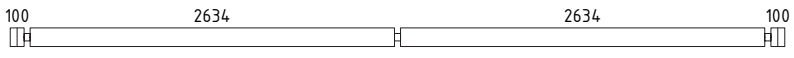
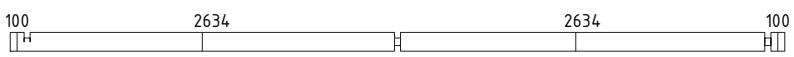

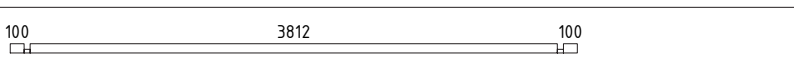
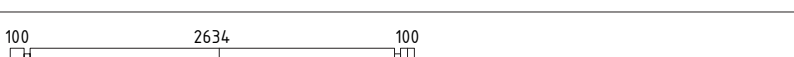
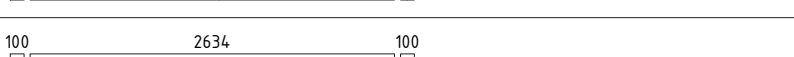
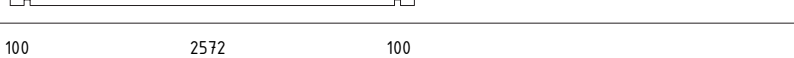
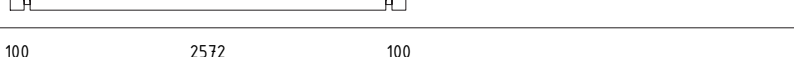
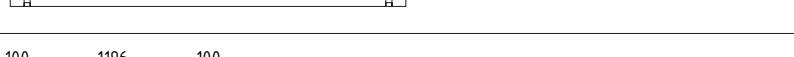



# Lagerholzplan und Fundamentplan Korpus für Cordoba/Malaga 44-B Modern

Wir empfehlen als Fundament für Ihr Gartenhaus eine vollflächig,  
festgegründete gepflasterte oder betonierte Fläche.  
Wahlweise ist auch ein Punkt- oder Streifenfundament möglich.





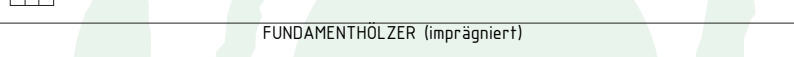
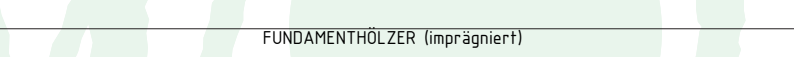
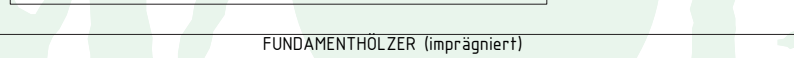
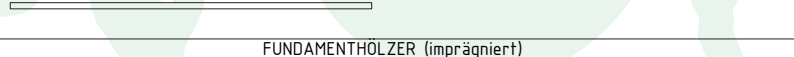







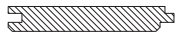

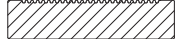

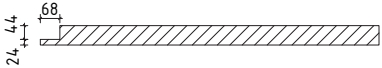
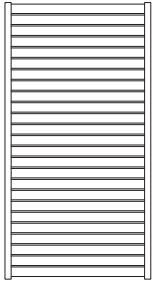





# Teileliste 1

## Korpus für Cordoba/Malaga 44-B Modern

Pos		Stck	Profil (mm)	Länge (mm)
001		16	44x135	5600
002		1	44x135	5600
003		15	44x135	4100
004		1	44x68	4100
005		1	44x135	2922
006		1	44x135	2922
007		15	44x135	2860
008		1	44x68	2860
009		15	44x135	1484
010		1	44x68	1484
011		30	44x135	718
012		14	44x135	454
013		14	44x135	454
014		6	44x135	444
015		2	44x135	444
016		7	44x135	444
017		1	44x68	444
018		12	44x135	314
019		2	44x135	314
FH4	 FUNDAMENTHÖLZER (imprägniert)	6	65x44	5250
FH1	 FUNDAMENTHÖLZER (imprägniert)	2	65x44	3880
FH5	 FUNDAMENTHÖLZER (imprägniert)	2	65x44	2613
FH6	 FUNDAMENTHÖLZER (imprägniert)	1	65x44	2572
FH3	 FUNDAMENTHÖLZER (imprägniert)	1	65x44	1197
FH2	 FUNDAMENTHÖLZER (imprägniert)	1	65x44	573

# Teileliste 2

## Korpus für Cordoba/Malaga 44-B Modern

Pos			Stck	Profil (mm)	Länge (mm)
	FUSSBODENBRETTER		24+1	113x18	3805
	FUSSBODENBRETTER		23	113x18	2565
	TERRASSENBRETTER (imprägniert)		22+1	120x28	1240
	FUSSBODENLEISTE		✓	18x40	19,0 lfm
SP1-1	STÜTZPFOSTEN 68x68		✓	68x68	2095
	GITTERWAND ELEMENT		1	1072x1994	
	LEISTE FÜR GITTERWAND		1	18x90	1994
SH	Schlaghölzer		3		
SS02	Schlossschrauben M8x70 Mutter U-Scheibe (für Gitterwand)		3	M8	
VP1	Verstellbare Pfostenstütze M10		1	M10	
ML1	Metallstange		4	D10	1170
KL1	Gewindestange M8		3	M8	2000
KL2	Gewindestange M8		1	M8	460
KL3	Gewindestange M8		2	M8	405
KL4	Gewindestange M8		2	M8	325
	Mutter M8 U-Scheibe Ø25		10	M8	
	Befestigungsmutter M8		3	M8	
NG1	NÄGEL 2.5x50 Fussbodenbretter		564		
NG2	NÄGEL 2.5x60 Terrassenbretter		132		
SR01	SCHRAUBEN 3.0x30 Fussbodenleisten		42		
SR03	SCHRAUBEN 3.5x45 Gitterwand Fenster- und Türleisten		86		
SR05	SCHRAUBEN 4.0x60 Wasserleisten WL1		10		





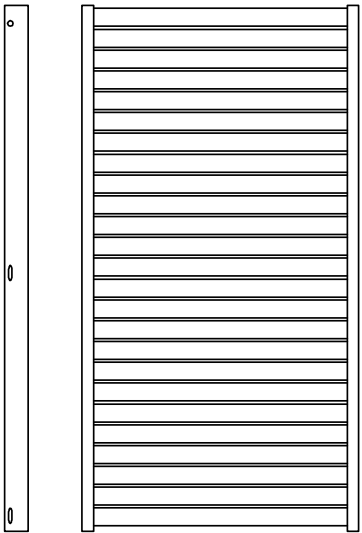

# Teileliste 3

## Korpus für Cordoba/Malaga 44-B Modern

### Montageanleitung für Gitterwand

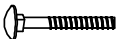

- Schrauben 3.5\*45mm 6 Stck. 
- Schrauben 5x70mm 4 Stck. 
- Schlossschrauben M8x70 3 Stck. 
- Mutter U-Scheibe 



Spiegelverkehrt



# Wandplan 1 und 2

## Korpus für Cordoba/Malaga 44-B Modern

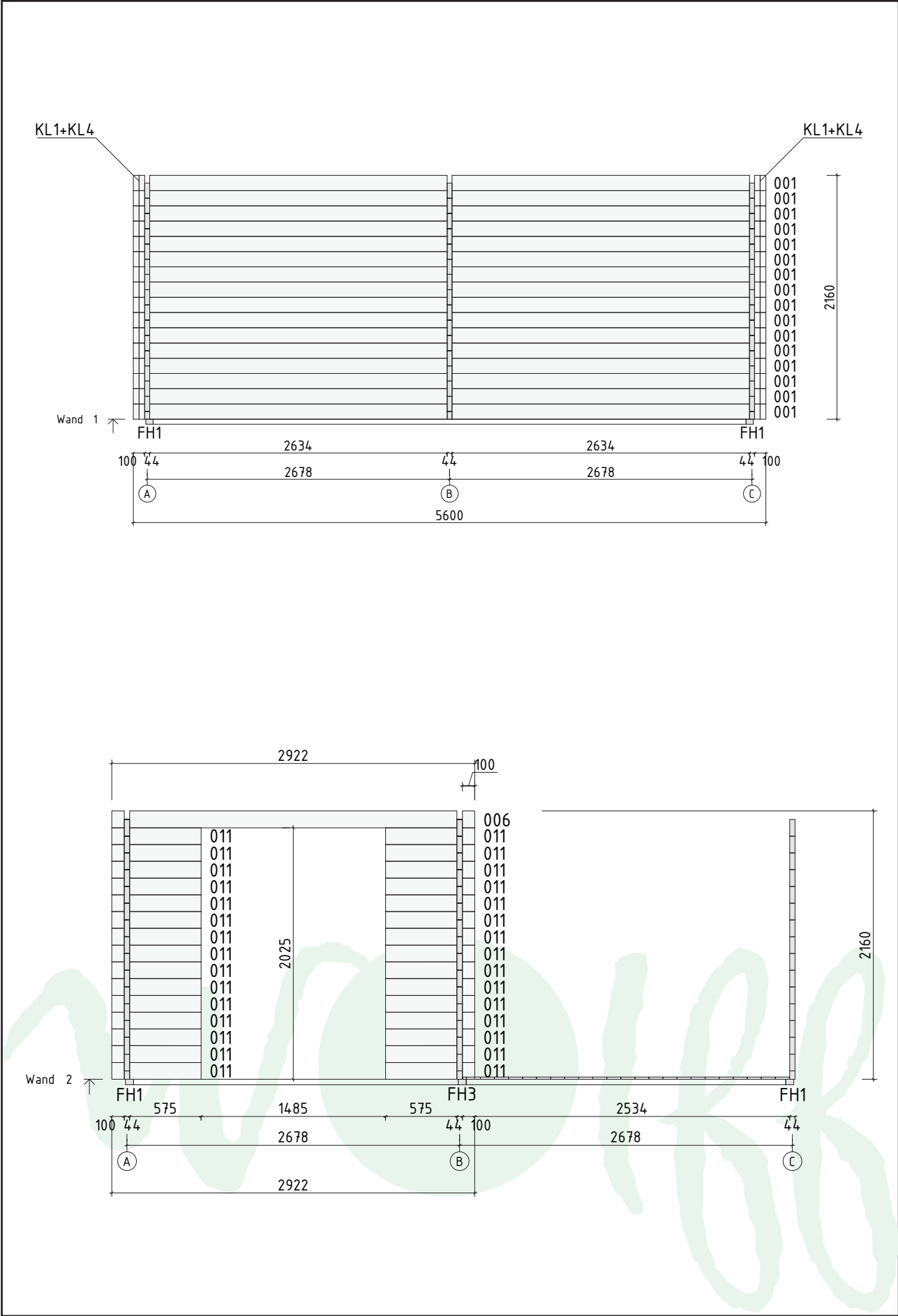



# Wandplan 3

## Korpus für Cordoba/Malaga 44-B Modern

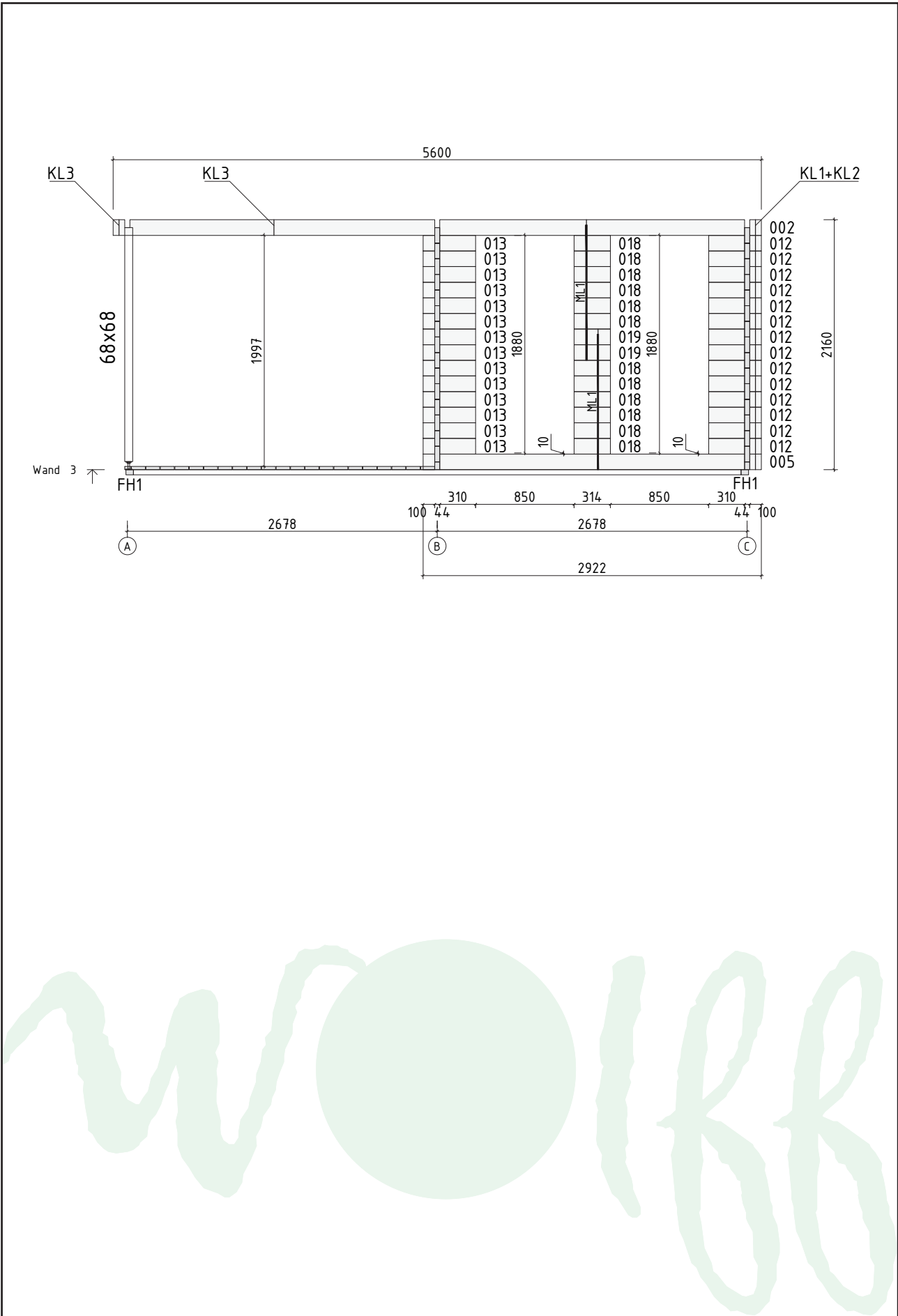



# Wandplan C

## Korpus für Cordoba/Malaga 44-B Modern

