

# Hammerfest 70-B XL

Wandaußenmaß: 360 x 360 cm

Bohlenstärke: 70 mm



Kontrolliert durch:

Achtung: Alle angegebenen Maße sind ca.-Maße!

# 3D-Darstellung und Grundriss Hammerfest 70-B XL

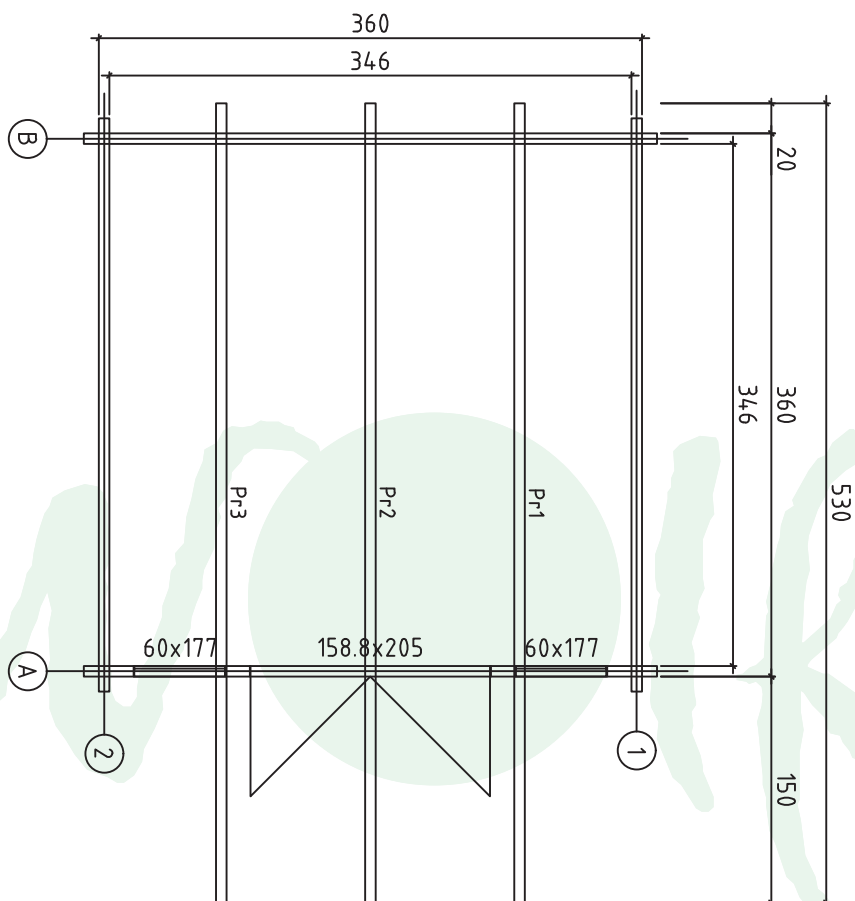
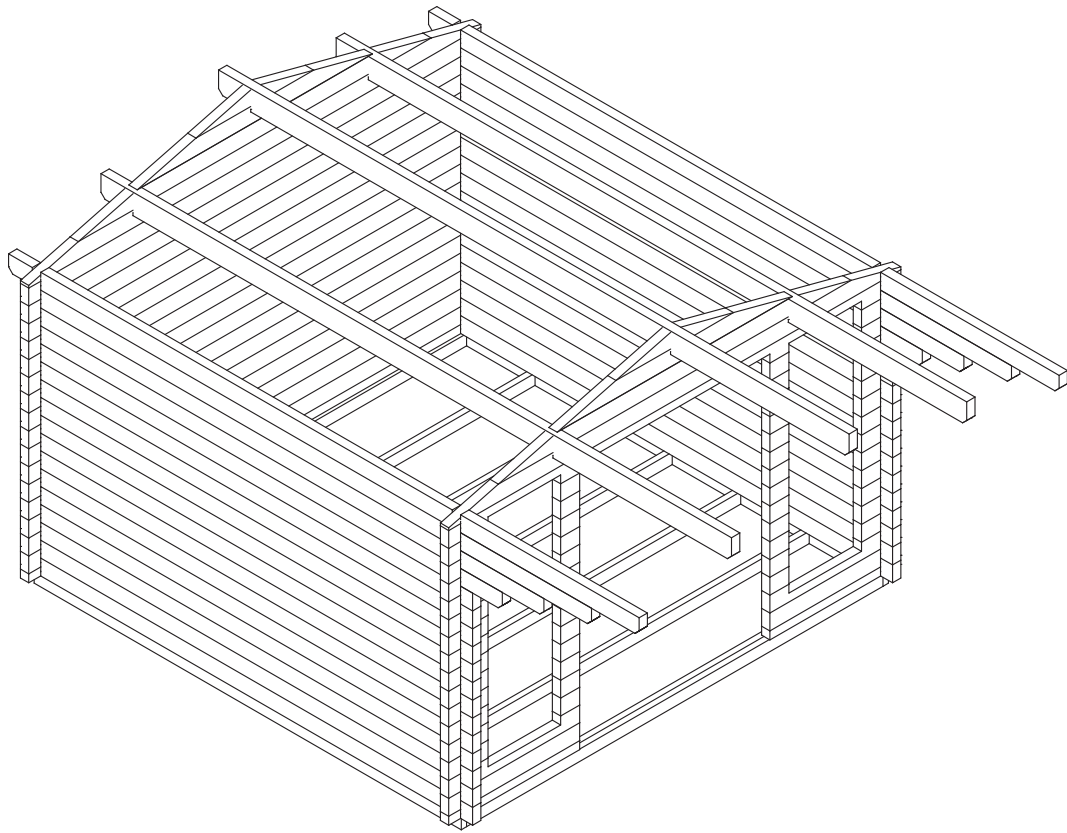





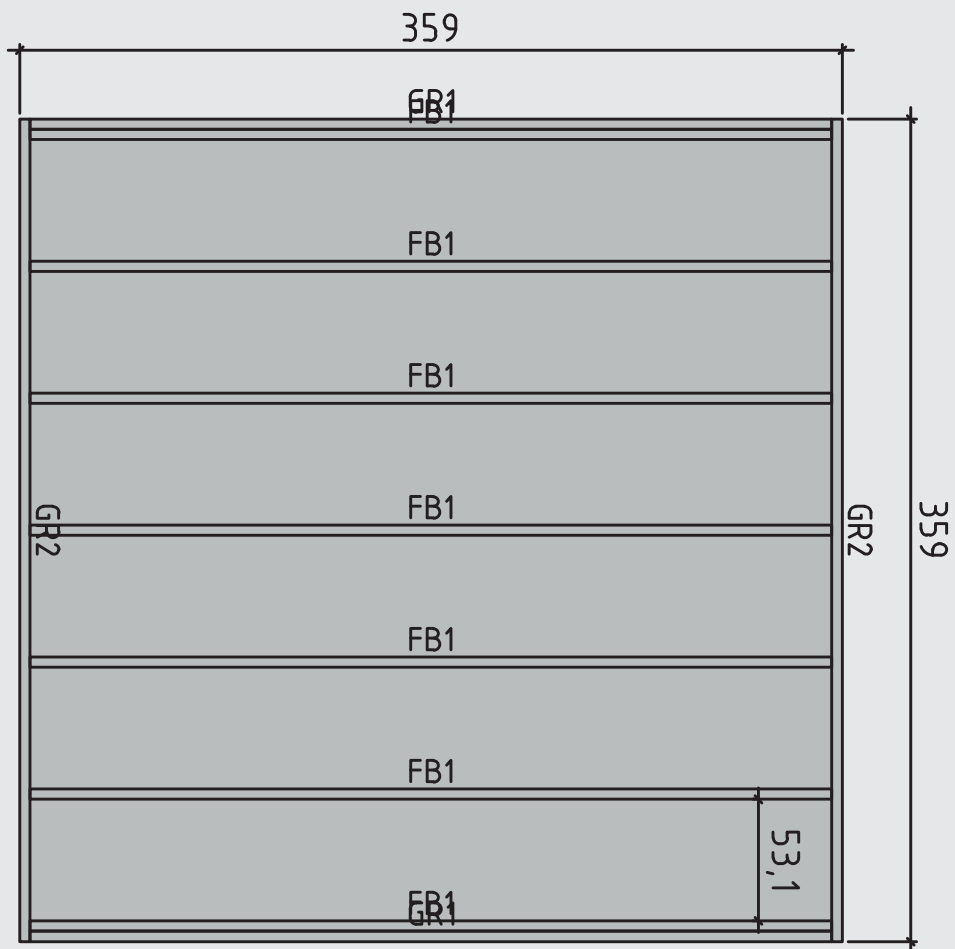





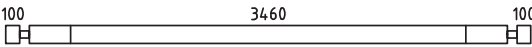
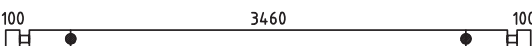
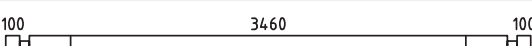
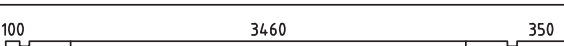
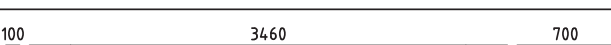
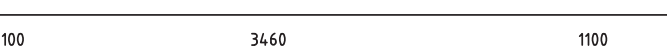

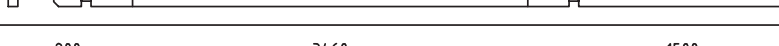
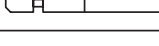
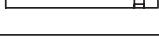
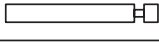

# Lagerholzplan und Fundamentplan Hammerfest 70-B XL

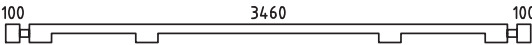
Wir empfehlen als Fundament für Ihr Gartenhaus eine vollflächig,  
festgegründete gepflasterte oder betonierte Fläche.  
Wahlweise ist auch ein Punkt- oder Streifenfundament möglich.

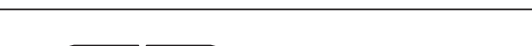
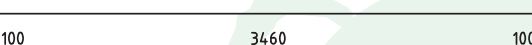
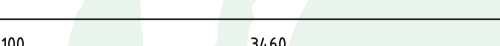

# Teileliste 1

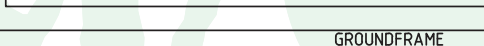
## Hammerfest 70-B XL

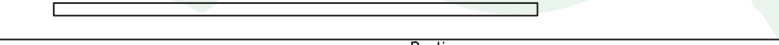
Pos			Profil (mm)	Lenght (mm)
001		2	70x130	3800
002		2	70x130	3800
003		22	70x130	3800
004		2	70x130	4050
005		2	70x130	4400
006		2	70x130	4800
007		1	70x130	5300
008		1	70x130	5300
009		2	70x65	1101
010		2	70x130	1101
011		2	70x130	1101
012		26	70x130	331
013		26	70x130	160
014		1	70x130	3800
015		2	70x130	3800
016		8	70x122	464
017		2	70x130	1917
018		2	70x130	1977
019		1	70x65	3800
020		16	70x130	3800
GR2	GROUNDFRAME 	2	45x90	3590
GR1	GROUNDFRAME 	2	45x90	3500
FB1	FLOORBEAMS 	7	45x90	3500
Pr1	Purlins 	1	70x170	5300
Pr2	Purlins 	1	70x170	5300

# Teileliste 2

## Hammerfest 70-B XL

Pos			Profil (mm)	Lenght (mm)
Pr3			70x170	5300
	WINDOW 600x1770			
	DOOR 1588x2050			
1	Screws/Schrauben/Vis 5x100 mm- For fixing first row of wall logs /Fixierung des ersten Bohlenkranzes/Pour fixer les lamesde plancher			6
2	Nails/Nägel/Clous 2.5x50 - For fixing floorboards/ Befestigung Fussbodenbretter/Pour fixer les lames de plancher			280
3	Nails/Nägel/Clous 2.5x50 - For fixing roofboards/ Befestigung Dachbretter/Pour fixer les voliges			370
4	Nails/Nägel/Clous 2.5x50 - For fixing floor edge trims/ Befestigung Fussleisten/Pour fixer les plinthes du plancher			30
5	Nails/Nägel/Clous 2.5x50 - For fixing roofing felt fillet/ Befestigung giebelabschlussbrett/Pour fixer la latte de finition de la couverture			20
6	Screws/Schrauben/Vis 2,5x50 mm- For fixing roof side boards and roof edge reinforcement Befestigung Traufenbretter und Traufenzeilen Pour fixer les planches de rive et le tasseau de refront			44
7	Screws/Schrauben/Vis 2,5x50 mm- For fixing fascia boards and diamonds/ Befestigung Giebelblende und Raute Pour fixer les planches de rive et le diamant			28
8	Screws/Schrauben/Vis 2,5x50 mm- For fixing fwindow and door trims/ Befestigung Fenster und türen/ Pour fixer les croisillons des fenestres et des portes			44
9	Metal storm Brace/Gewindestange/Tige filetee 10 mm			4
10	Shim;Nuts/Mutter ,U-Scheibe/Ecrou;Rondelle 10 mm For fixing storm braces/ Pour fixer les anti tempete/ Für Sturmleisten Pour fixer les croisillons des fenestres et des portes			4 / 4
	Metal storm Brace/Gewindestange/Tige filetee 10 mm KLZ M10 2,31 m 4 Screws 180 8 pcs. Plastic caps 4 pcs.			

# Teileliste 3

## Hammerfest 70-B XL

POS	ST.	B	H	L	Teileliste
FB1	Vt. spetsi				FUNDMENTHOLZER
F1	12 m <sup>2</sup>	28		3455	FUSSBODENBRETTER 40/31/26
PR	3	70	170	5300	DACHBALKEN
RB1	22,5 m <sup>2</sup>	20		2120	DACHBRETTER 122/94/78
R1	2	20	120	5300	<i>Vaata katuse kaldenurka</i> Traufenbretter
R2	2	45	65	5300	<i>Vaata katuse kaldenurka</i> Traufenbretter
R3	4	20	120	2300	<i>Vaata katuse kaldenurka</i> Giebelabschlussleiste
R4	4	20	90	2300	Giebelabschlussleiste
WN06	2	600	1770		<p style="margin: 0;">Sliding slats 30x30x1575 mm - 4 pcs.</p>
DR16	1	1588	2050		
P1	15 m	20	40		Fußbodenleiste
P2	6+6	20	90	2030	Türleiste DR 16, Fensterleiste WN 06
P3	1+1	20	90	3440	Türleiste DR 16, Fensterleiste WN 06
P4	2+2	20	90	<del>540</del> 570	Fensterleiste WN 06



# Detailzeichnungen Hammerfest 70-B XL

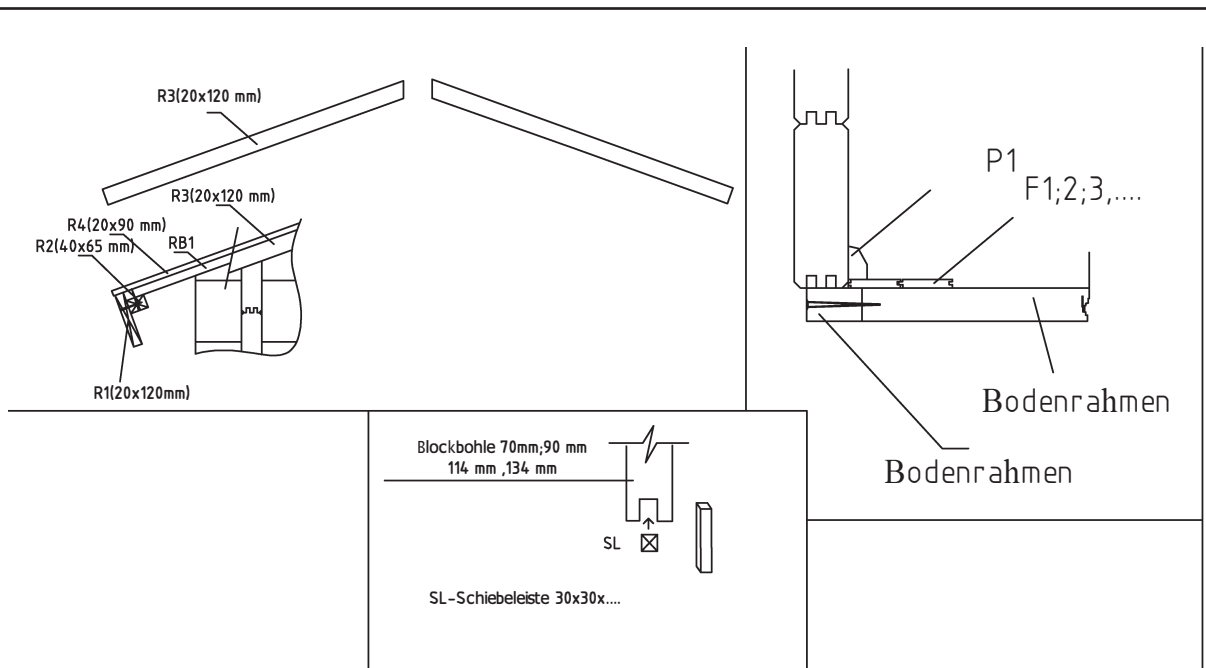

## Dichtungssystem der Blockbohlen

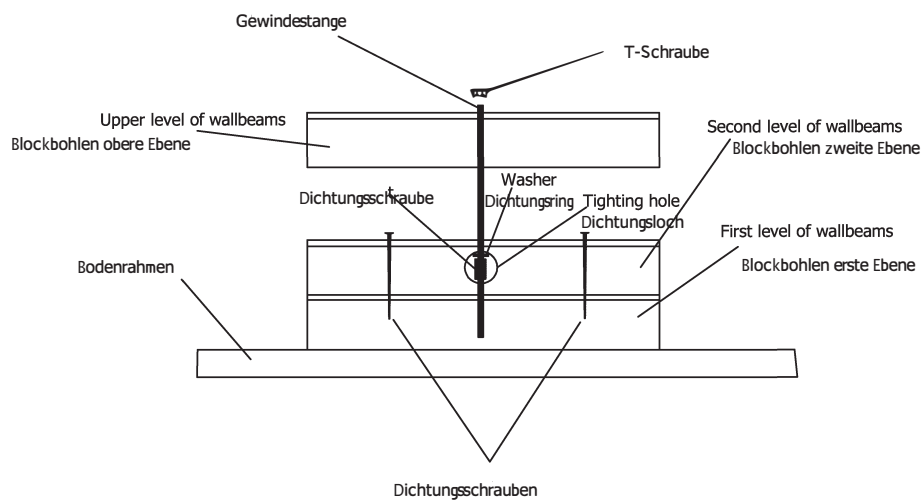

# Wandplan 1 und 2 Hammerfest 70-B XL

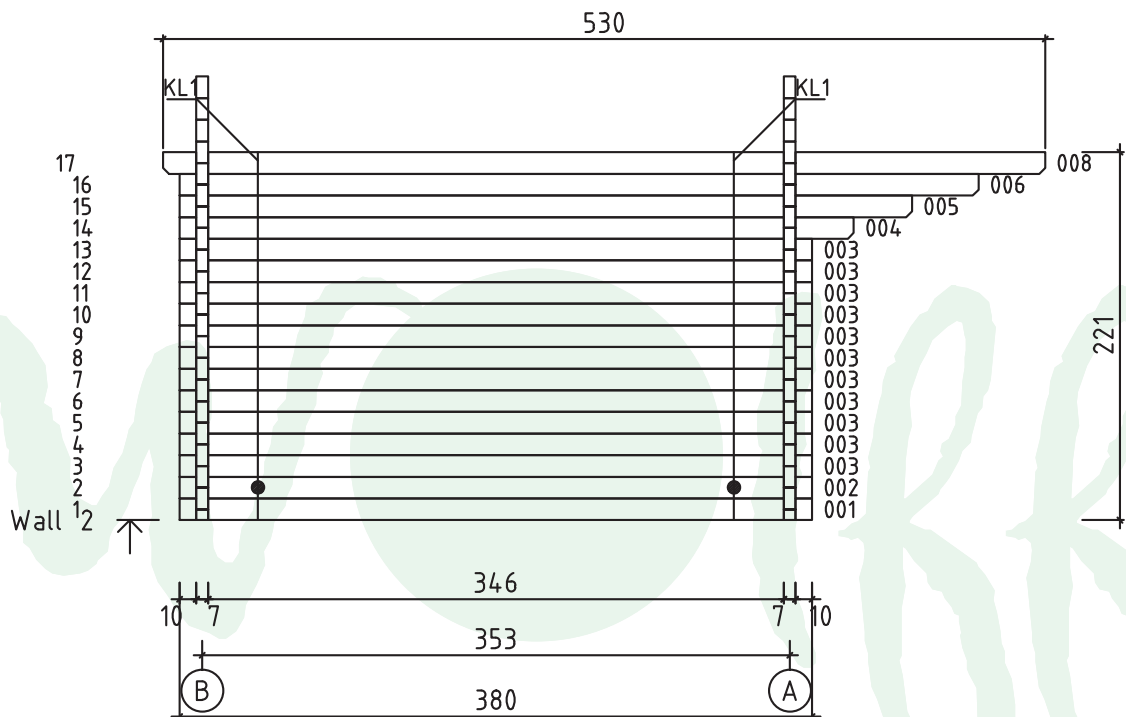
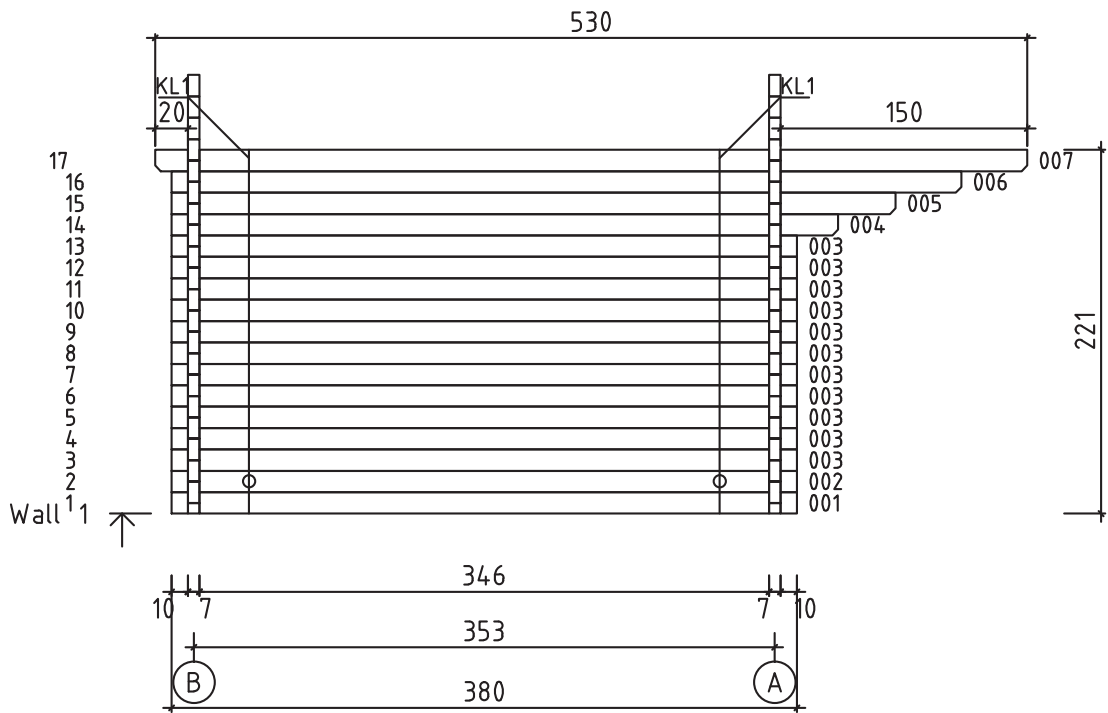



# Wandplan A und B Hammerfest 70-B XL

