

# Hammerfest 70-G XL

Wandaußenmaß: 530 x 530 cm

Bohlenstärke: 70 mm



Kontrolliert durch:

Achtung: Alle angegebenen Maße sind ca.-Maße!

# 3D-Darstellung und Grundriss Hammerfest 70-G XL

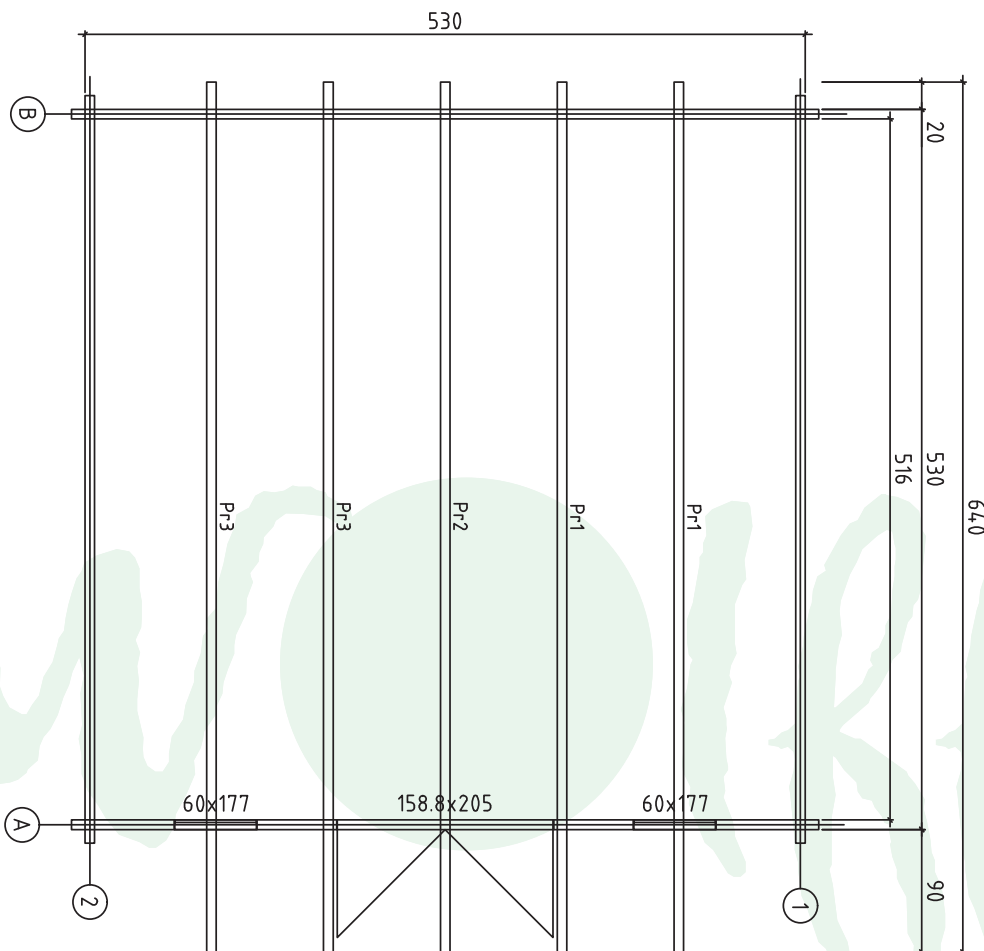
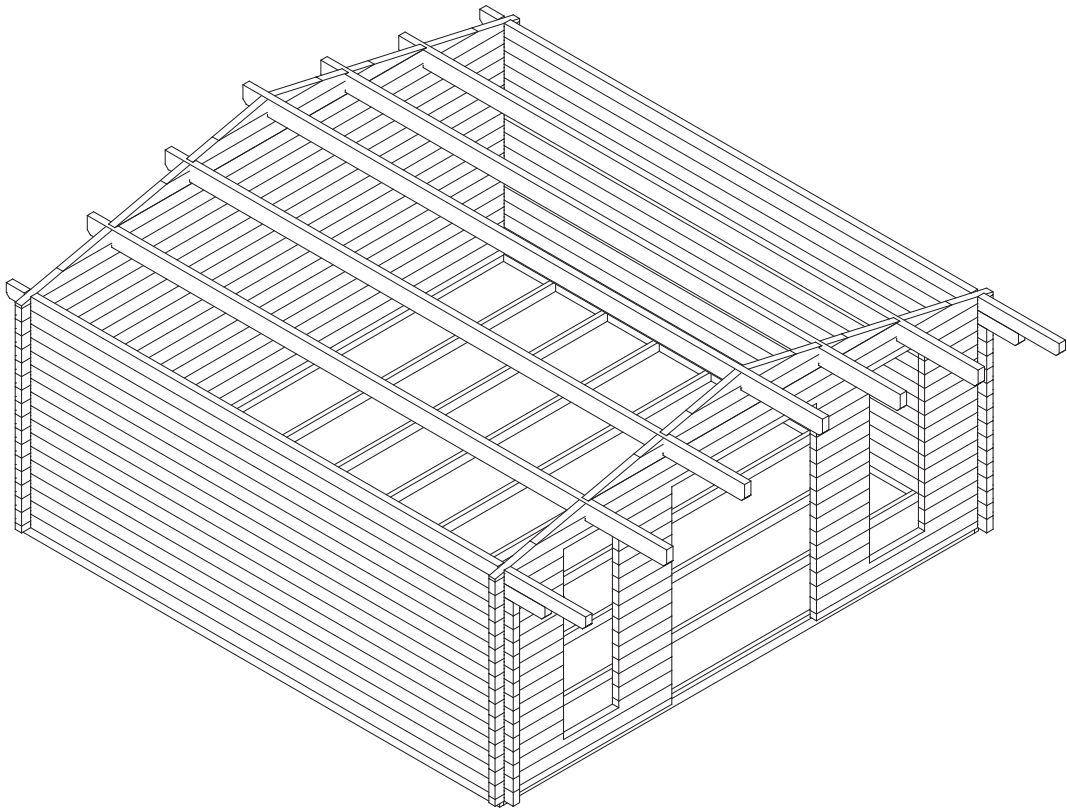





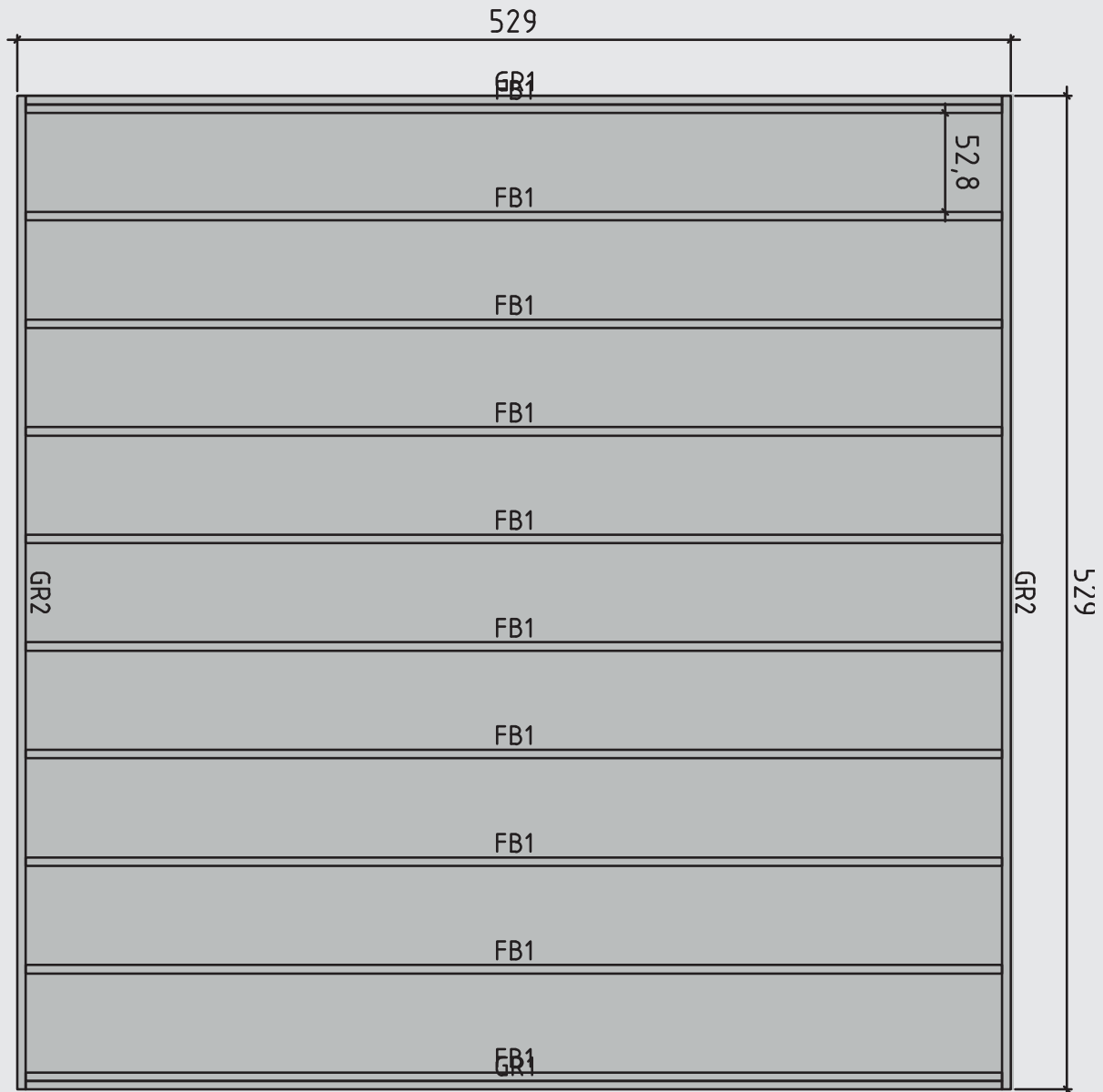





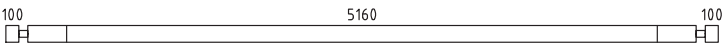
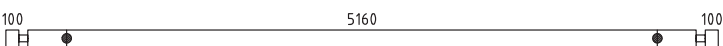
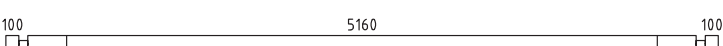
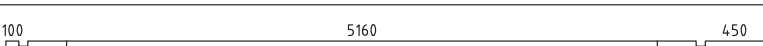

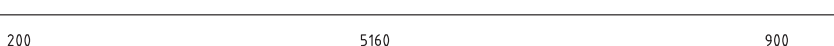
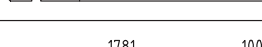

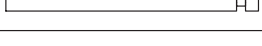
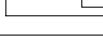

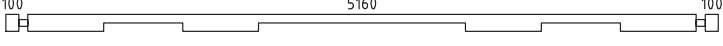
# Lagerholzplan und Fundamentplan Hammerfest 70-G XL

Wir empfehlen als Fundament für Ihr Gartenhaus eine vollflächig,  
festgegründete gepflasterte oder betonierte Fläche.  
Wahlweise ist auch ein Punkt- oder Streifenfundament möglich.

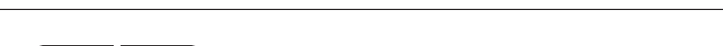

# Teileliste 1

## Hammerfest 70-G XL

Pos			Profil (mm)	Lenght (mm)
001			70x130	5500
002			70x130	5500
003			70x130	5500
004			70x130	5850
005			70x130	6400
006			70x130	6400
007			70x65	1951
008			70x130	1951
009			70x130	1951
010			70x130	756
011			70x130	586
012			70x130	5500
013			70x130	5500
014			70x123	543
015			70x130	3380
016			70x130	3440
017			70x58	257
018			70x130	1719
019			70x65	5500
020			70x130	5500
GR2		GROUNDFRAME	45x90	5290
GR1		GROUNDFRAME	45x90	5200
FB1		FLOORBEAMS	45x90	5200
Pr1		Purlins 5160	70x170	6400
Pr2		Purlins 5160	70x170	6400

# Teileliste 2

## Hammerfest 70-G XL

Pos			Profil (mm)	Lenght (mm)
Pr3		Purlins 5160	70x170	6400
	WINDOW 600x1770			2
	DOOR 1588x2050			1
1	Screws/Schrauben/Vis 5x100 mm- For fixing first row of wall logs /Fixierung des ersten Bohlenkranzes/Pour fixer les lamesde plancher			6
2	Nails/Nägél/Clous 2.1x50 - For fixing floorboards/ Befestigung Fussbodenbretter/Pour fixer les lames de plancher			495
3	Nails/Nägél/Clous 2.1x50 - For fixing roofboards/ Befestigung Dachbretter/Pour fixer les voliges			550
4	Nails/Nägél/Clous 2.1x50 - For fixing floor edge trims/ Befestigung Fusleisten/Pour fixer les plinthes du plancher			30
5	Nails/Nägél/Clous 2.1x50 - For fixing roofing felt fillet/ Befestigung giebelabschlussbrett/Pour fixer la latte de finition de la couverture			20
6	Screws/Schrauben/Vis 3,5x50 mm- For fixing roof side boards and roof edge reinforcement Befestigung Traufenbretter und Traufleisten Pour fixer les planches de rive et le tasseau de refrent			44
7	Screws/Schrauben/Vis 3,5x50 mm- For fixing fascia boards and diamonds/ Befestigung Giebelblende und Raute Pour fixer les planches de rive et le diamant			28
8	Screws/Schrauben/Vis 3,5x50 mm- For fixing fwindow and door trims/ Befestigung Fenster und türen/ Pour fixer les croissilons des fenetres et des portes			68
9	Metal storm Brace/Gewindestange/Tige filetee 10 mm			4
10	Shim,Nuts/Mutter ,U-Scheibe/Ecrou,Rondelle 10 mm For fixing storm braces/ Pour fixer les anti tempete/ Für Sturmleisten Pour fixer les croissilons des fenetres et des portes Metal storm Brace/Gewindestange/Tige filetee 10 mm KLI M10 2,31 m 4 Screws 180 8 pcs. Plastic caps 4 pcs.			4/4

# Teileliste 3

## Hammerfest 70-G XL

POS	ST.	B	H	L	ERKLÄRUNG
FB1	Vt. spetsi				FLOORBEAMS
F1	26,62m <sup>2</sup>	28		5155	FUSSBODENBRETTER 55/42/35
PR	5	70	170	6400	ROOFBEAMS
RB1	38,08m <sup>2</sup>	20		2975	Dachbretter 138/108/88
R1	4	20	120	3200	Vaata katuse kaldenurka Frontboard
R2	4	45	65	3200	Vaata katuse kaldenurka Frontboard fixing board
R3	4	20	120	3200	Vaata katuse kaldenurka Girders facade
R4	4	20	90	3200	Topboard
WN06	2	600	1770		<p style="margin: 0;">Sliding slats 30x30x1575 mm - 4 pcs.</p>
DR16	1	1588	2050		
P1	22 m	20	40		Floor edge trim
P2	6+6	20	90	2030	Türleiste DR 16, Fensterleiste WN 06
P3	2+2	20	90	900	Fensterleiste WN 06
P4	2+2	20	90	540 570	Fensterleiste WN 06
P5	1+1	20	90	1890	Türleiste DR 16

# Detailzeichnungen Hammerfest 70-G XL

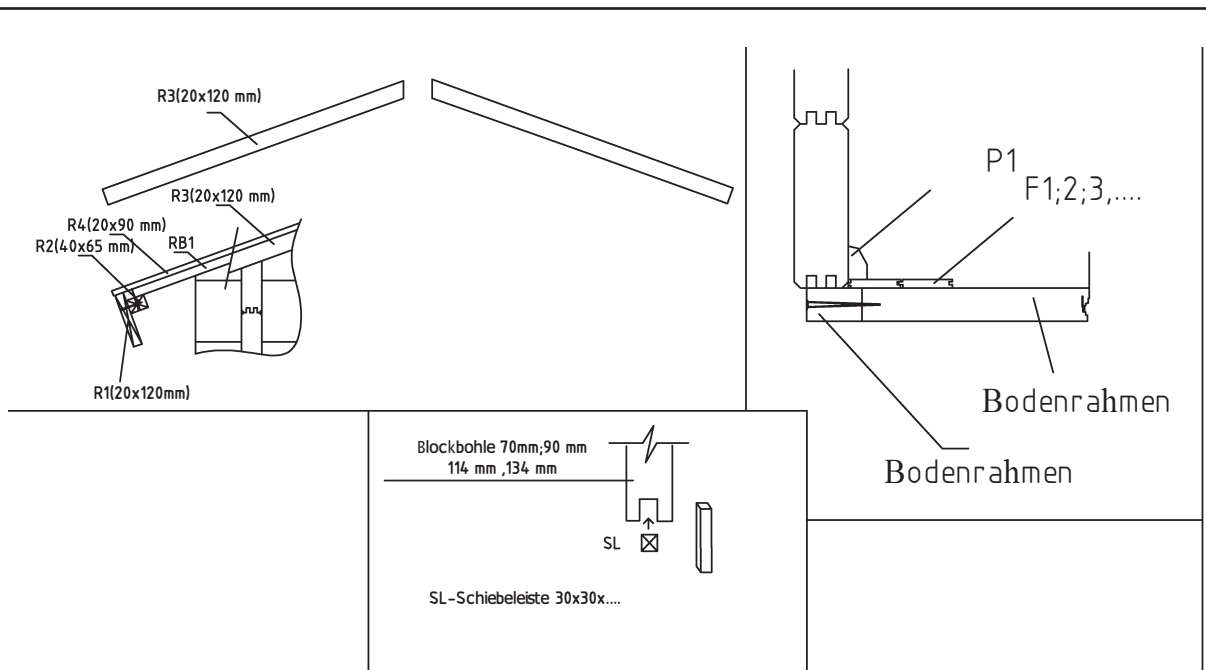

## Dichtungssystem der Blockbohlen

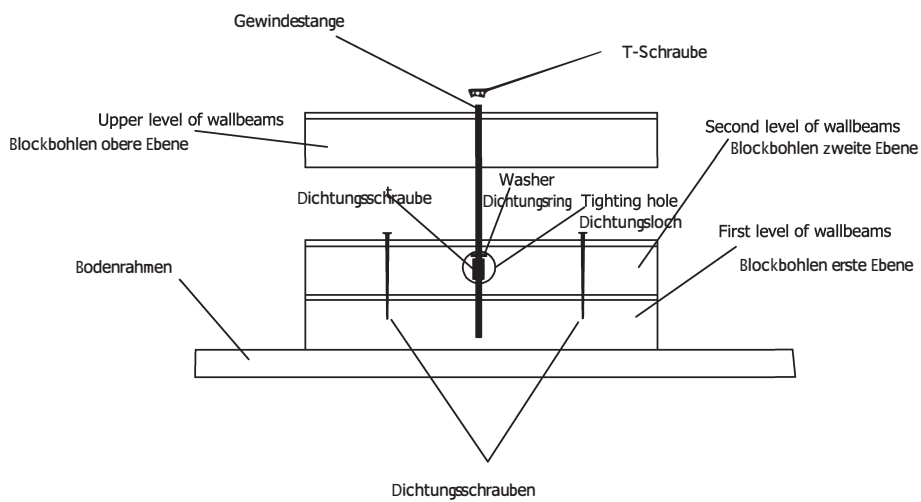

# Wandplan 1 und 2 Hammerfest 70-G XL

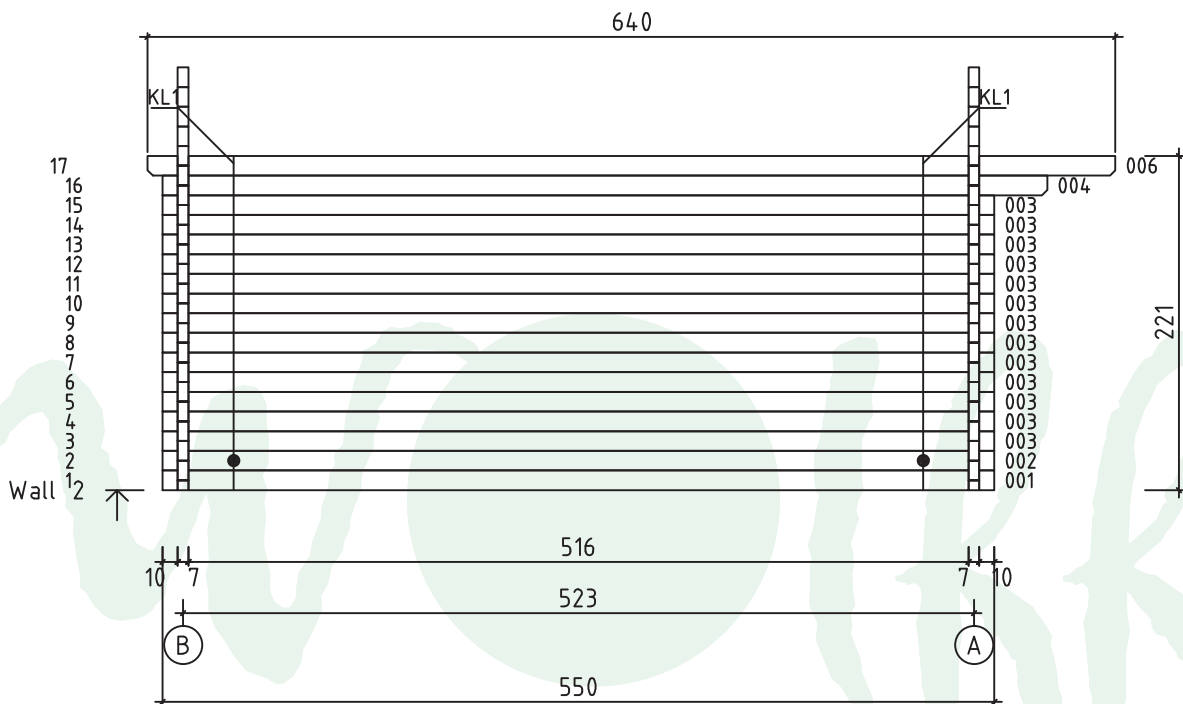
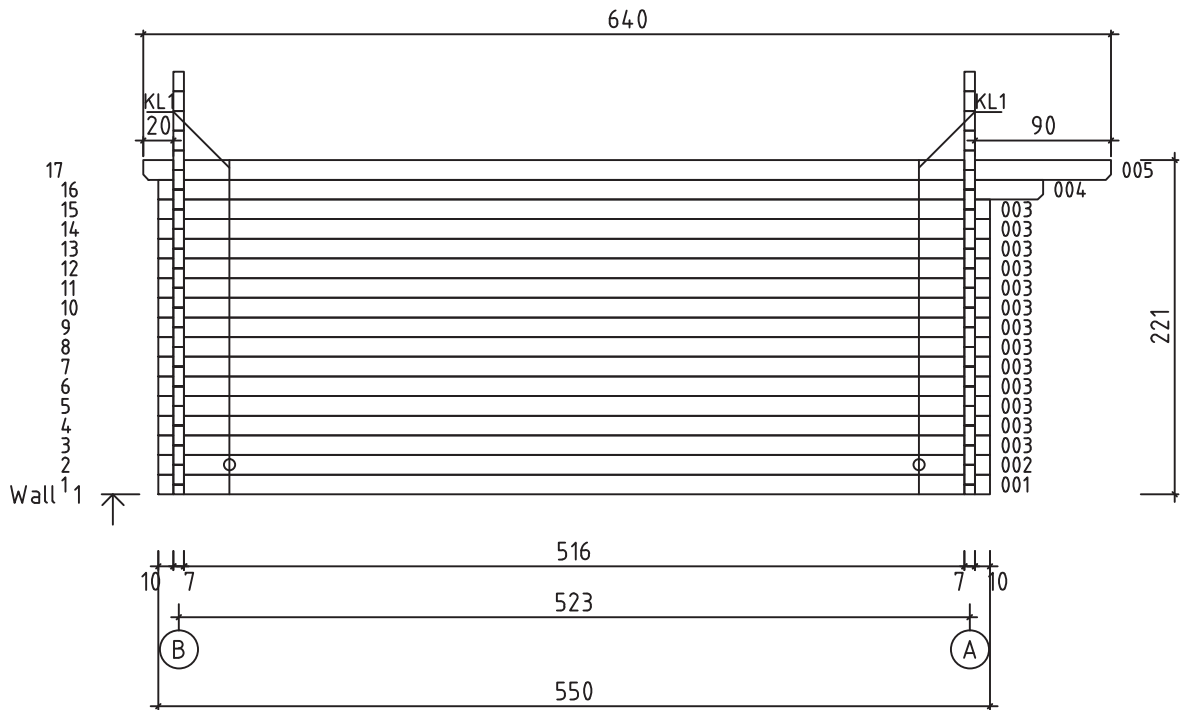



# Wandplan A und B Hammerfest 70-G XL

