

Lappland 70 A XL

Wandaußenmaß: 500 x 500 cm

Bohlenstärke: 70 mm



Lappland 70-B, durch Kunden farblich endbehandelt

Kontrolliert durch:

Achtung: Alle angegebenen Maße sind ca.-Maße!

3D-Darstellung und Grundriss Lappland 70 A XL

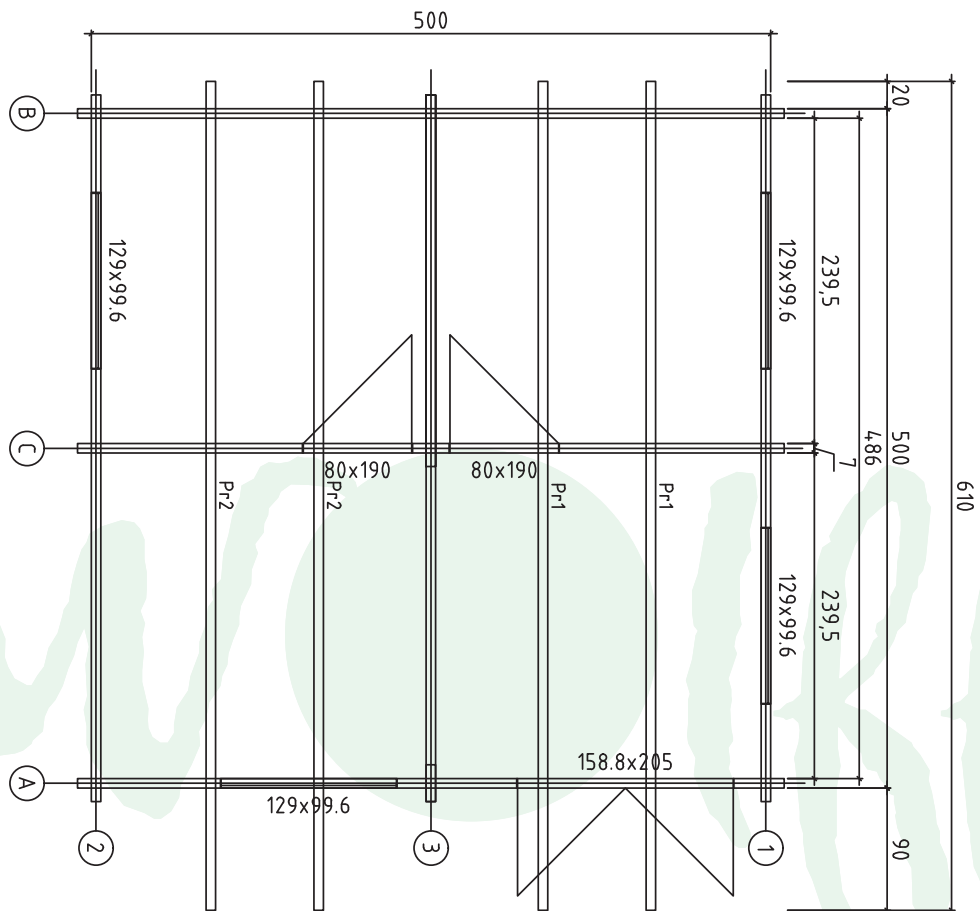
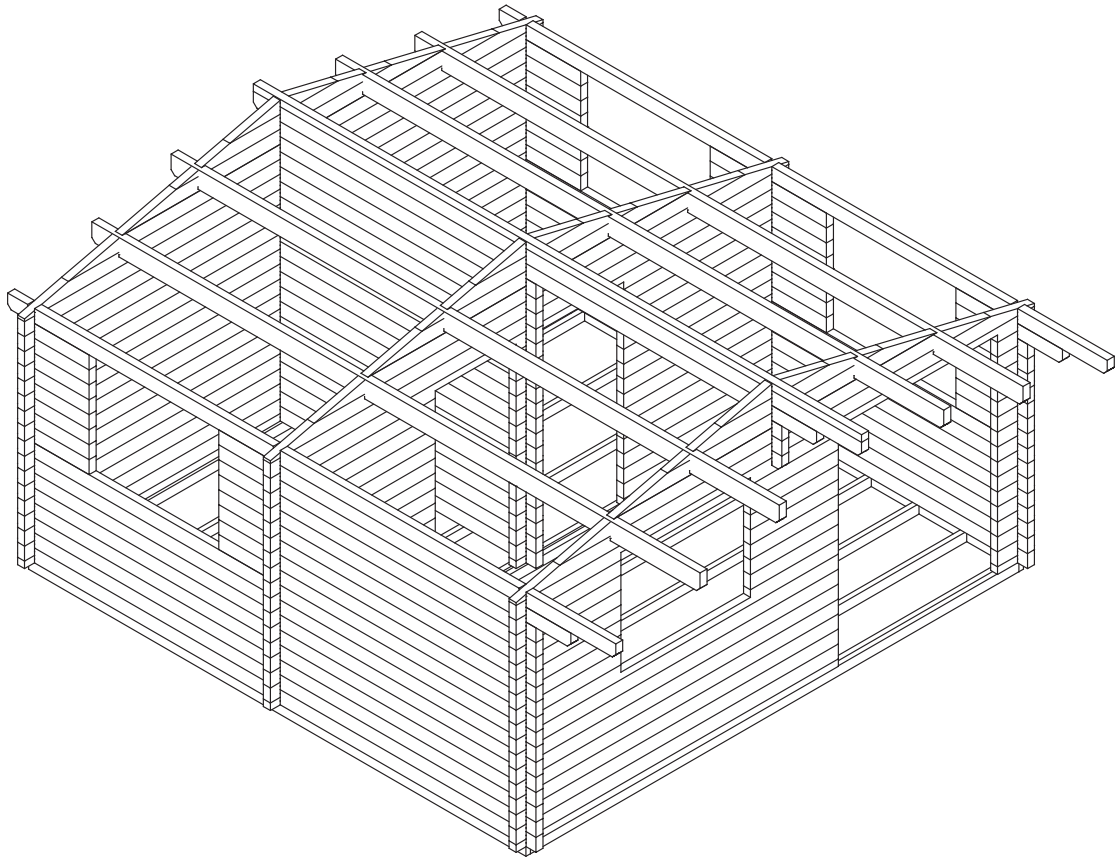





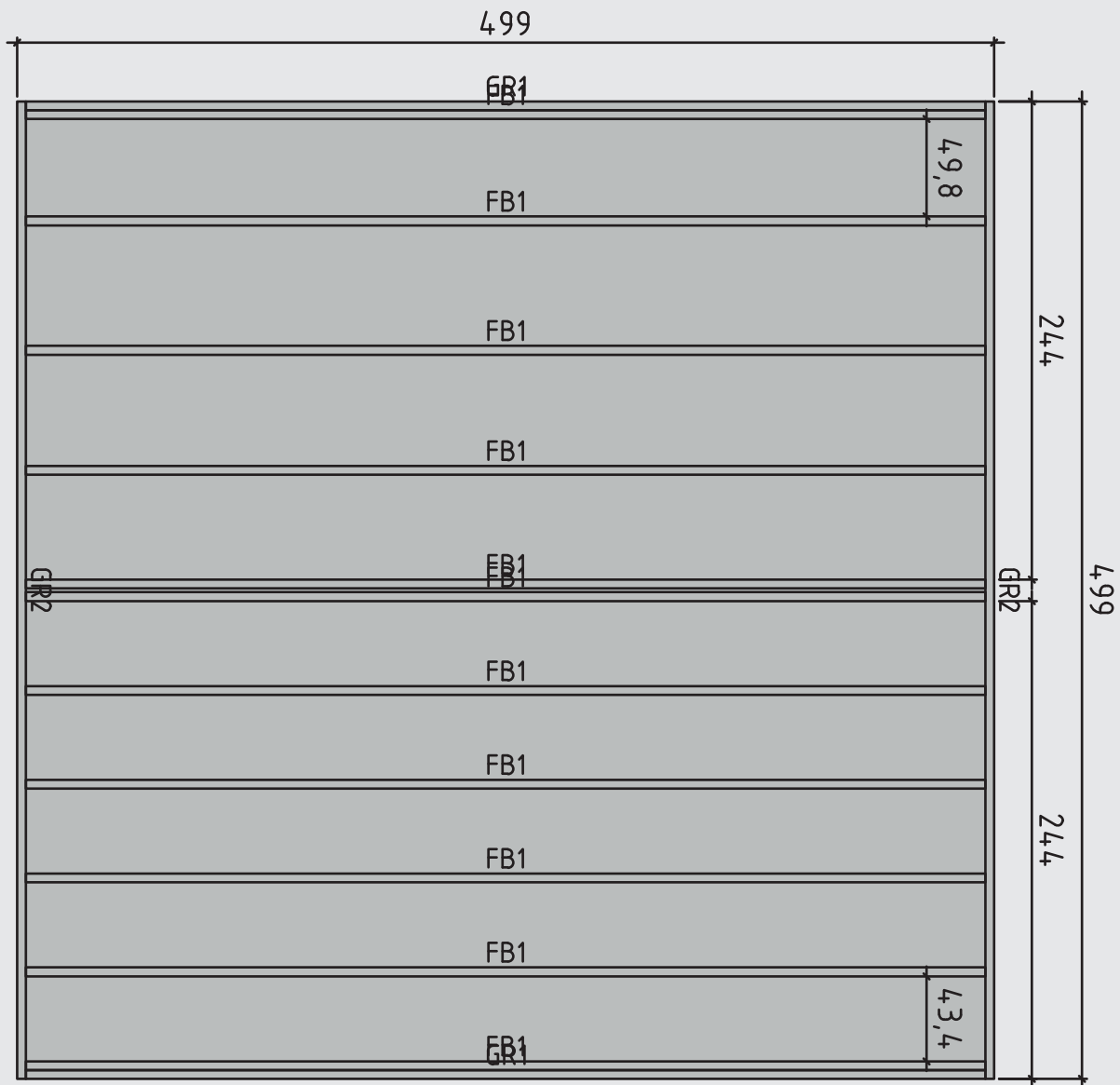







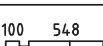
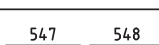
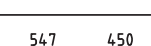

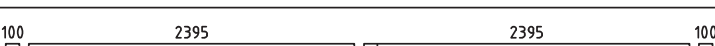
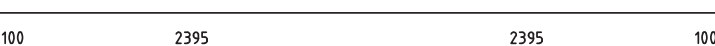
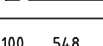
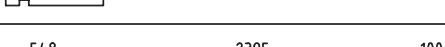
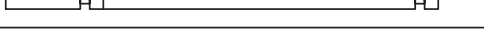
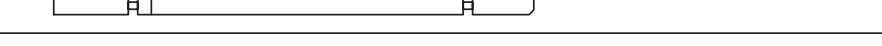
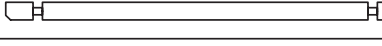
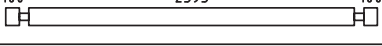
Lagerholzplan und Fundamentplan Lappland 70 A XL

Wir empfehlen als Fundament für Ihr Gartenhaus eine vollflächig,
festgegründete gepflasterte oder betonierte Fläche.
Wahlweise ist auch ein Punkt- oder Streifenfundament möglich.













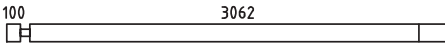
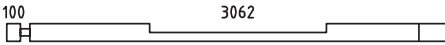
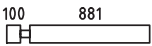
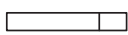
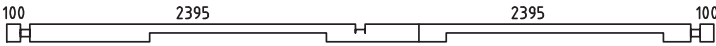

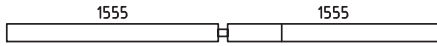



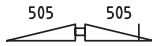

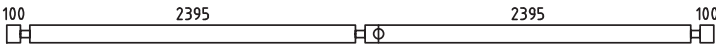
Teileliste 1

Lappland 70 A XL

Pos			Profil (mm)	Lenght (mm)
001		1	70x130	5200
002		1	70x130	5200
003		6	70x130	5200
004		15	70x130	718
005		8	70x130	1165
006		1	70x130	1068
007		1	70x130	6100
008		1	70x130	5200
009		1	70x130	5200
010		21	70x130	5200
011		8	70x130	718
012		7	70x130	3183
013		1	70x130	3533
014		1	70x130	6100
015		1	70x130	2735
016		18	70x130	2735
017		1	70x130	270
018		16	70x130	270
019		1	70x130	5550
020		1	70x130	6100
021		1	70x65	6100
022		1	70x65	3232
023		1	70x65	370
024		1	70x130	3232
025		15	70x130	370

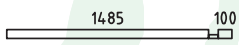

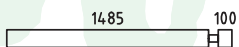

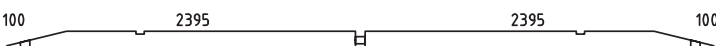





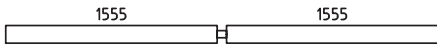
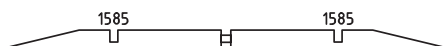



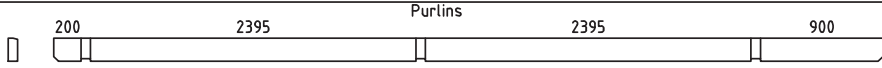
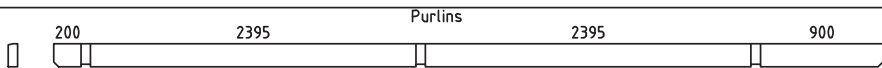

Teileliste 2

Lappland 70 A XL

Pos			Profil (mm)	Lenght (mm)
026		6	70x130	3232
027		1	70x130	3232
028		7	70x130	1051
029		7	70x130	881
030		1	70x130	5200
031		1	70x130	5200
032		6	70x123	510
033		1	70x130	3180
034		1	70x130	3240
035		6	70x54	225
036		1	70x130	1650
037		1	70x122	1080
038		1	70x65	5200
039		1	70x130	5200
040		1	70x130	5200
041		1	70x130	3180
042		1	70x130	3240
043		1	70x130	1650
044		1	70x122	1080
045		2	70x65	1655
046		1	70x65	270
047		28	70x130	1655
048		1	70x130	5200
049		1	70x130	5200
050		1	70x130	5200

















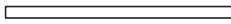

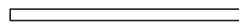

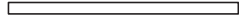
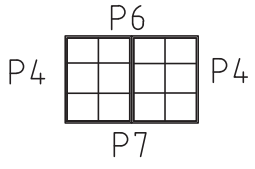
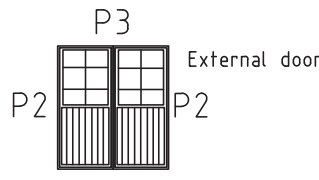

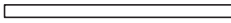
Teileliste 3

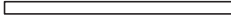
Lappland 70 A XL

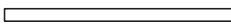
Pos		Profil (mm)	Lenght (mm)
051		70x130	3180
052		70x130	3240
053		70x130	1650
054		70x122	1080
GR2	GROUNDFRAME 	45x90	4990
GR1	GROUNDFRAME 	45x90	4900
FB1	FLOORBEAMS 	45x90	4900
Pr1	Purlins 	70x170	6100
Pr2	Purlins 	70x170	6100
	WINDOW 1290x996		4
	DOOR 1588x2050		1
	DOOR 800x1900		2
1	Screws/Schrauben/Vis 5x100 mm- For fixing first row of wall logs /Fixierung des ersten Bohlenkranzes/Pour fixer les lamesde plancher 		6
2	Nails/Nägel/Clous 2.1x50 - For fixing floorboards/ Befestigung Fussbodenbretter/Pour fixer les lames de plancher 		495
3	Nails/Nägel/Clous 2.1x50 - For fixing roofboards/ Befestigung Dachbretter/Pour fixer les voliges 		550
4	Nails/Nägel/Clous 2.1x50 - For fixing floor edge trims/ Befestigung Fussleisten/Pour fixer les plinthes du plancher 		30
5	Nails/Nägel/Clous 2.1x50 - For fixing roofing felt fillet/ Befestigung giebelabschlussbrett/Pour fixer la latte de finition de la couverture 		20
6	Screws/Schrauben/Vis 3,5x50 mm- For fixing roof side boards and roof edge reinforcement Befestigung Traufenbretter und Traufenleisten Pour fixer les planches de rive et le tasseau de refront 		44
7	Screws/Schrauben/Vis 3,5x50 mm- For fixing fascia boards and diamonds/ Befestigung Giebelblende und Raute Pour fixer les planches de rive et le diamant 		28
8	Screws/Schrauben/Vis 3,5x50 mm- For fixing fwindow and door trims/ Befestigung Fenster und türen/ Pour fixer les croisillons des fenestres et des portes 		68
9	Metal storm Brace/Gewindestange/Tige filetee 10 mm 		5
10	Shim/Nuts/Mutter ,U-Scheibe/Ecrou/Rondelle 10 mm For fixing storm braces/ Pour fixer les anti tempete/ Für Sturmleisten Pour fixer les croisillons des fenestres et des portes Metal storm Brace/Gewindestange/Tige filetee 10 mm KLI M10 2,89 m 2 Screws 180 10pcs. KL2 M10 2,31m 3 Plastic caps 5 pcs. 		5/5

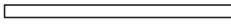
Teileliste 4

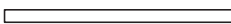
Lappland 70 A XL

POS	ST.	B	H	L	ERKLÄRUNG
FB1	Vt. spetsi				 FLOORBEAMS
F1	23,61m ²	28		2390	 FUSSBODENBRETTER 55/42/35
PR	4	70	170	6100	 ROOFBEAMS
RB1	34,52m ²	20		2830	 Dachbretter 138/108/88
R1	4	20	120	3050	<i>Vaata katuse kaldenurka</i>  Frontboard 
R2	4	45	65	3050	<i>Vaata katuse kaldenurka</i>  Frontboard fixing board 
R3	4	20	120	3050	<i>Vaata katuse kaldenurka</i>  Girders facade 
R4	4	20	90	3050	 Topboard 
WN29	4	1290	996		
DR15	1	1588	2050		 External door
DR08	2	800	1900		
P1	35m	20	40		 Floor edge trim
P2	2+2	20	90	2030	 Fixing boards for DR15 
P3	1+1	20	90	1890	 Fixing boards for DR15 
P4	20	20	90	1100	 Fixing boards for DR08 and WN29 
P5	4+4	20	90	1880	 Fixing boards for DR08 
P6	4+4	20	90	1590	 Fixing boards for WN29 
P7	4+4	20	90	1250	 Fixing boards for WN29 

Detailzeichnungen Lappland 70 A XL

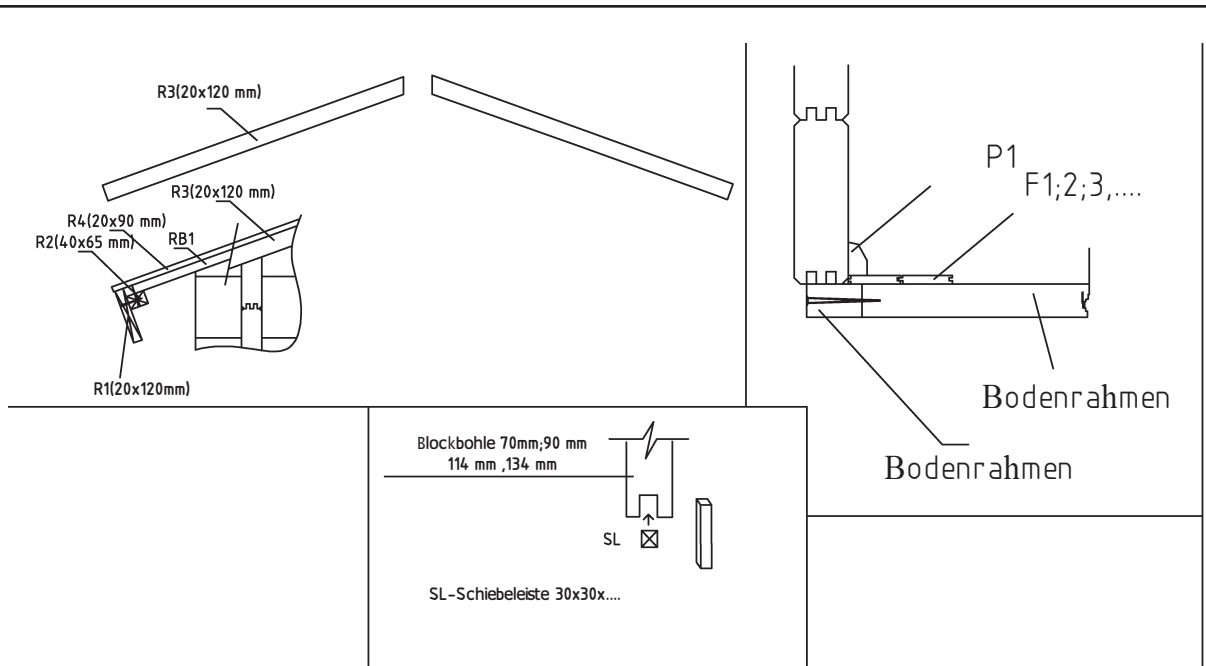

Dichtungssystem der Blockbohlen

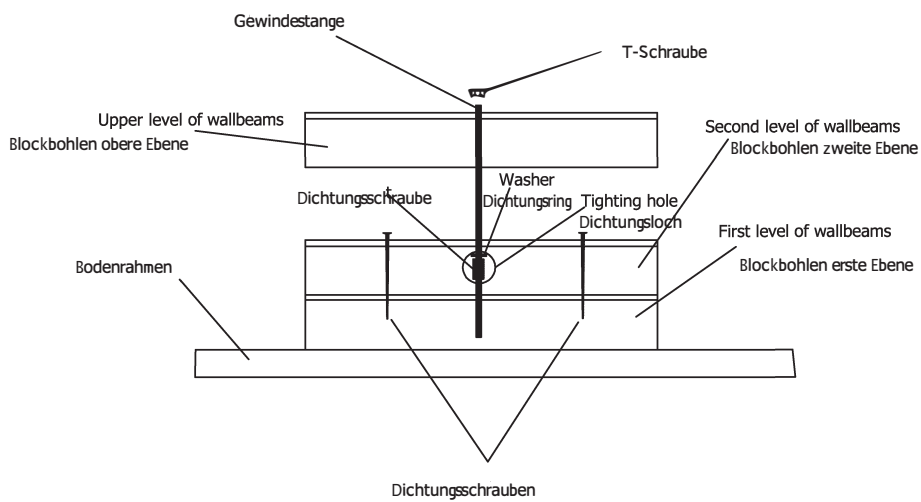

Wandplan 1 und 2 Lappland 70 A XL

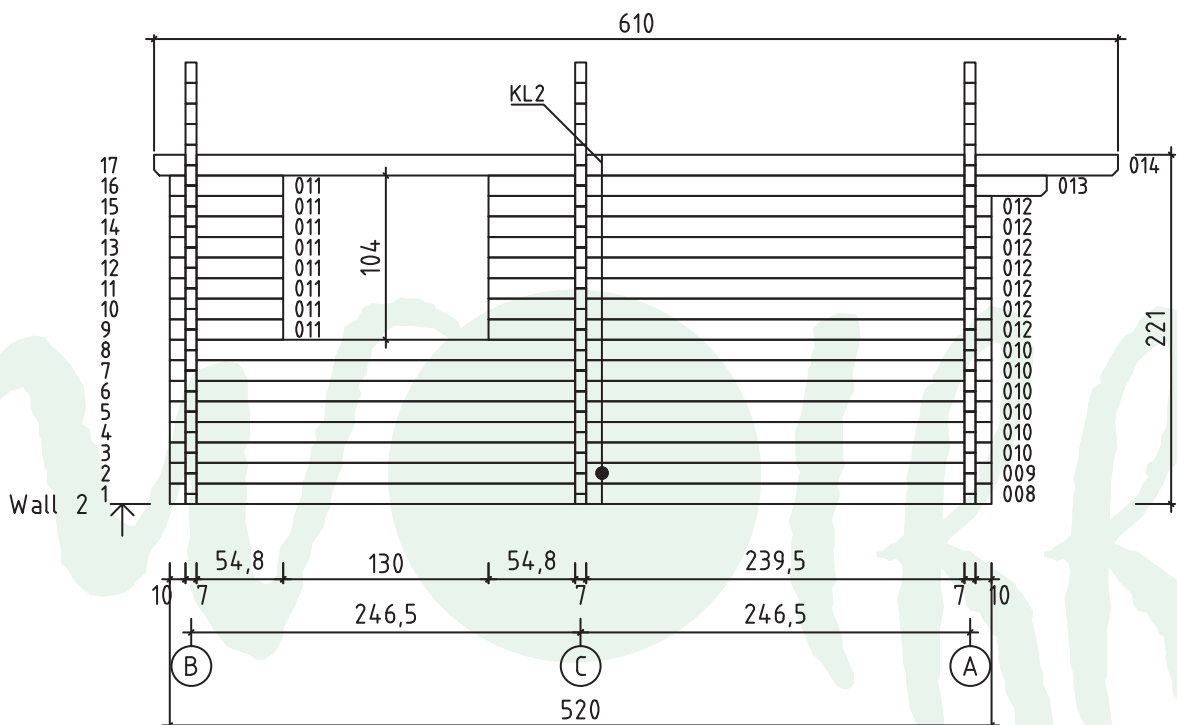
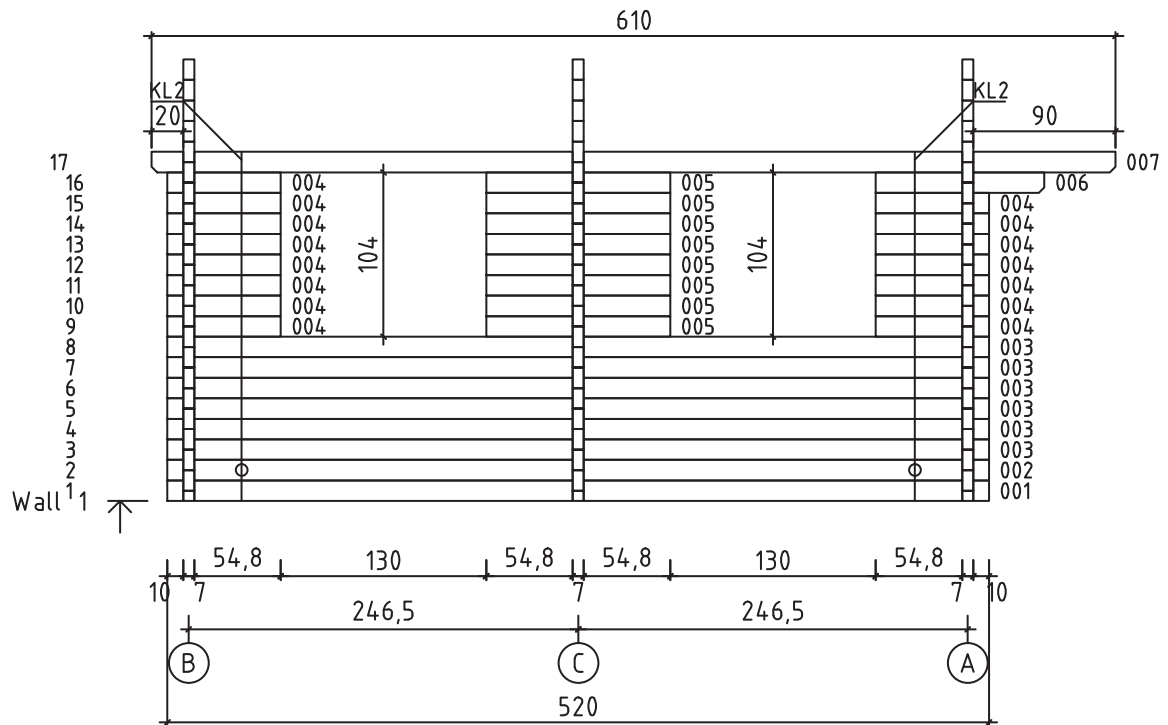

Wandplan 3 Lappland 70 A XL

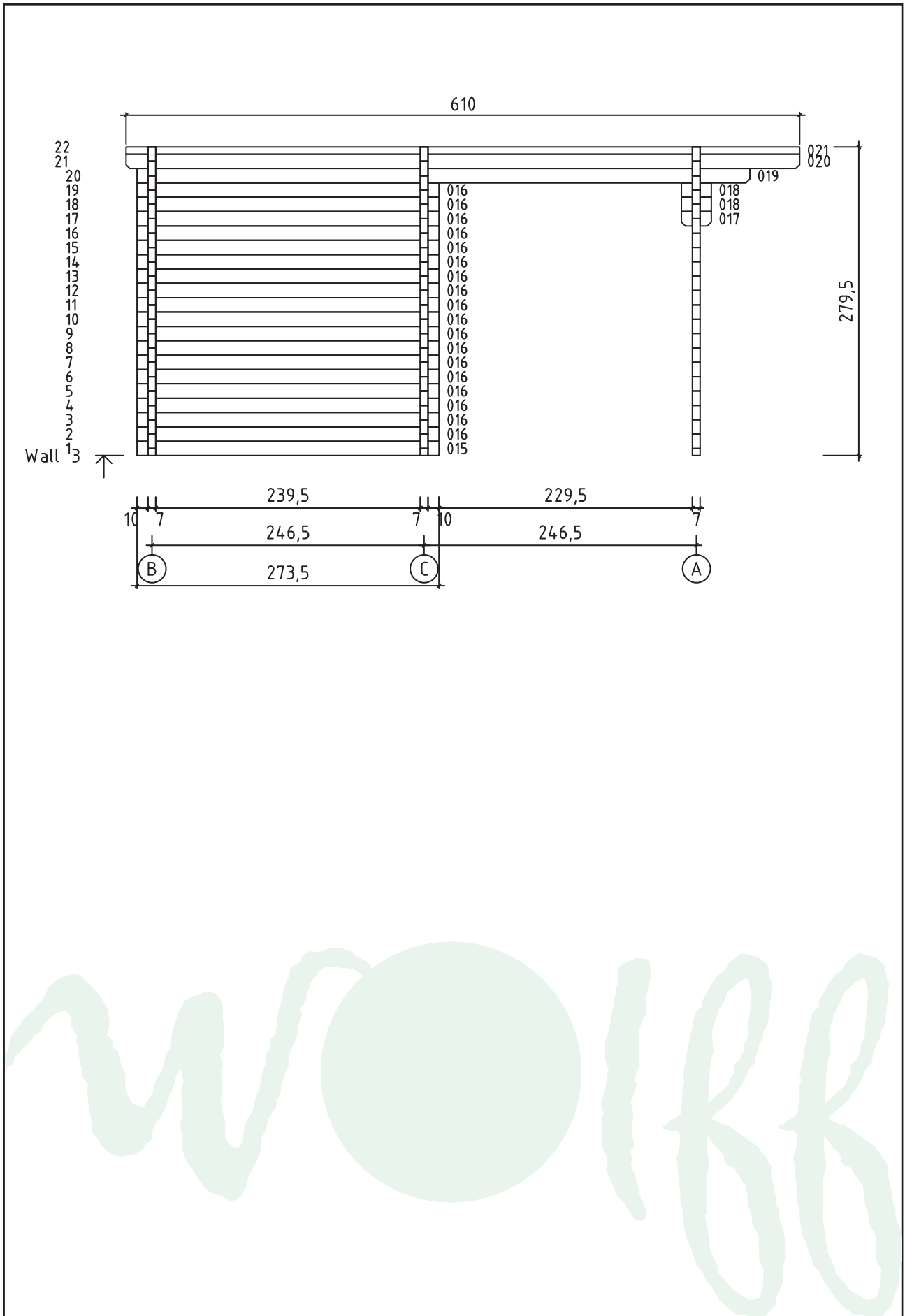

Wandplan A und B Lappland 70 A XL

